

Technology and Automation

Two disciplines from a single source



Editorial



Nina Pildner-Steinburg and Wolfgang Senner are ensuring the stability and development of the family business since 2016.

Dear valued business partners,

You have high expectations for us – and so you should!

After all, it is our job to help your company succeed. Since the founding of GAW in 1951, this intention has been part of our corporate DNA and a guarantee of technological expertise in the international paper and board industry and in other industrial segments. This is particularly true for the production of pigment, the preparation of coating colour and coating compounds, starch and chemicals, or the cleaning and recycling of process wastewater that contains pigment.

Based on your specific needs, we design integrated process solutions with the corresponding cost-benefit potential. We also ensure the timely start-up of your plant via precise project planning, well-founded process technology with associated automation, and effective project management.

This brochure provides insight into our range of services and describes our complex expertise and experience – which our business partners have trusted and relied on for decades.

Entrepreneurship, the courage to move forward, and a consistent international orientation have always characterized us, and we are justifiably proud of this as a family business. Our innovative, high-quality and reliable machinery, process equipment and services will also meet your needs and reaffirm your confidence in us.

We look forward to working with you!

Nina Pildner-Steinburg & Wolfgang Senner
Management, GAW technologies GmbH

Content

GAW technologies

| | |
|------------------------|----|
| Editorial..... | 02 |
| Content | 03 |
| GAW technologies | 04 |
| AutomationX..... | 05 |

Industrial Plants

| | |
|----------------------------------------|----|
| Everything from a single source..... | 08 |
| Supply, unloading and storage | 10 |
| Chemicals preparation | 11 |
| GCC preparation..... | 12 |
| Powder preparation..... | 13 |
| Starch preparation..... | 14 |
| Heat recovery system | 15 |
| Dispersing machines..... | 16 |
| Working station..... | 17 |
| Deaerators..... | 18 |
| Sodium dithionite solvent system | 19 |
| Coating colour kitchen | 20 |
| Coating colour recovery system | 22 |
| Membrane separation plants..... | 24 |

Key Components „made in Austria“

| | |
|--------------------------------------------------------------------------------|----|
| ECO-R filter | 28 |
| ECO-S filter | 30 |
| Dispersing machines..... | 32 |
| Top-drive system | 34 |
| Bottom-drive system..... | 36 |
| ContiMixer | 38 |
| Agitators, mixing systems, special apparatus construction..... | 40 |
| GAW Ultramill..... | 42 |
| GAW Airvent | 44 |
| GAW Airvac | 46 |
| GAW Airmem | 48 |
| Laboratory dispersion equipment..... | 50 |
| Quality loop..... | 51 |
| automationX® | 52 |
| Advanced process control-solutions (APC) | 54 |
| Production management systems for batch and continuous operation (MES)..... | 57 |

Synergy Projects

| | |
|-------------------------------------------------------------|----|
| SAPPI, GAW technologies, AutomationX | 60 |
| Mayr-Melnhof Karton, GAW technologies, AutomationX | 64 |
| Owens Corning..... | 66 |

Innovation and Development

| | |
|--------------------------------------|----|
| Laboratory and technical centre..... | 70 |
|--------------------------------------|----|

GAW Group

| | |
|--------------------------------------------|----|
| The GAW Group..... | 72 |
| Corporate structure of the GAW Group | 74 |

GAW technologies

Your partner in excellence



Entrepreneurial spirit, courage and a good intuition for developments – this is how the history of GAW started. In 1951 Erhardt Pildner-Steinburg founded the “Grazer Armaturen-Werk” and started the successful development from a valve manufacturer to an international group for industrial engineering and plant construction.

The company began its inception with a staff of five in a garage. They manufactured drive sections for wood processing machines as well as machine feeds for the paper industry. During the 1960s the start into the business area plant construction succeeded with a kaolin dissolving plant for the Steyermühl paper mill.

In 1974, his two sons Jochen and Jörg took over the lead and successfully continued the chosen path. Their leadership reinforces the international establishment as a highly reputed

plant construction company and as a preferred supplier of key equipment and technology, especially in the field of coating colour preparation in the production of refined paper and cardboard. The complex plants are designed to meet customer-specific requirements and include the core processing steps for the preparation of coating colour: dispersing, mixing and agitating, cooking, milling, deaerating and filtering.

Today, GAW technologies with its world-wide locations, serves as a guarantor of technological expertise in many industries, especially when it comes to the fully automated preparation and production of pigment, starch, chemicals, coating colour and coating compounds as well as the cleaning and recycling of process wastewater containing pigments. GAW provides process solutions ranging from development, consultancy and engineering, to logistics, supervision and commissioning, as well as training and after sales service.

AutomationX

Solutions without limits



AutomationX and GAW technologies, two strong partners within the GAW Group, have already automated and optimized hundreds of systems in the pulp and paper industry worldwide.

In more than two decades of collaboration, AutomationX has gained a hands-on understanding of the demanding process of producing coated paper and cardboard. This includes comprehensive knowledge of the process chain, the processes and the actual requirements for automation solutions in the pulp and paper industry.

The focus here is on process automation, process control (including visualization, batch handling, product and material tracking), process optimization and process simulation.

In excellent cooperation with partner companies and system integrators – including voestalpine, Inteco and BDI –

AutomationX solutions were implemented beyond the paper division, allowing the company's business activities to be successively internationalized.

Today, the company realizes global projects in the paper & pulp, food, building materials, petrochemical, manufacturing, infrastructure and energy sectors, with thousands of installations worldwide.

automationX® is an ideal platform for the control of new systems, the retrofitting of existing systems as well as the optimization of processes for the best possible use of resources.

Industrial Plants

Everything from a single source

As the supplier for coating colour preparation systems, GAW technologies has decades of experience and impressive worldwide references in the planning, delivery, installation and commissioning of complete coating colour kitchens.

In the coating colour kitchen, the coating colours are processed by dosing and dispersing individual components in a special mixing unit according to the given recipe, based on quantity and time sequence. The coating formulations depend on the application of the paper, the paper machine, the coating process and the location. Depending on the desired technical and optical properties of the paper quality (e.g. surface weight, density, strength, roughness, brightness, whiteness, opacity, gloss), pigments, binders and additives are used in the dispersion. Dispensing is therefore the central, quality-determining step in coating colour preparation.

For this reason, GAW technologies has persistently improved the process and technology of its dispersing units in dependable partnerships with key customers and developed them into highly efficient dispersing systems.

The GAW dispersing machines are the heart of every coating colour kitchen and are constructed under the premises of energy efficiency, consistent and reproducible qualities, scalability, preservation of the medium and optimal process connection.

SUPPLY, UNLOADING AND STORAGE

In the area of delivery, unloading and storage, media are pumped via a fine filter into the storage container. The delivery of the products is mostly by truck, railway wagon or container.

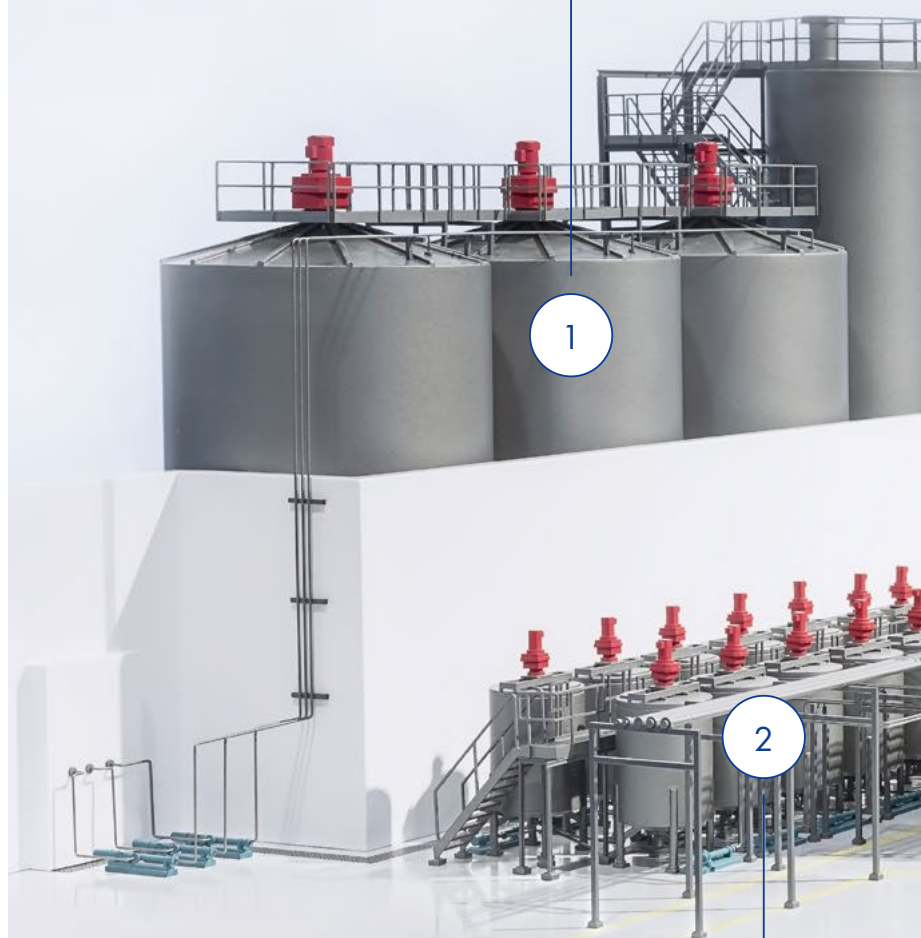

CHEMICALS PREPARATION

Auxiliary substances are also referred to as additives. They are either mixed directly into the paper stock or applied to the paper at certain points on the paper machine or by a coater.

STARCH PREPARATION

Starch powder is mixed with water to form a slurry and reduced or cooked depending on the application.

DISPERSING MACHINE

In the dispersing machine, the heart of the coating kitchen, pigments and additives are dispersed into a coating.

COATING COLOUR STORAGE

The dispersion is pumped into the coating colour storage and gently stirred to prevent segregation and sedimentation.

WORKING STATION

The working station is a circulatory system, via which homogenized coating colour, surface glue and other coating agents from the storage containers of the coating colour kitchen are pumped via filters into working containers. They are then pumped via further filters to the coating heads.

DEAERATOR

Deaerators extract air from the coating compound, enabling the bubble-free coating application on the paper.

GCC

PREPARATION
The GAW Ultramill grinds calcium carbonate into fillers and the finest coating pigment. The system achieves fineness levels of 60% ≤ 2 microns, to 75% ≤ 2 microns, up to 90%, 95% and 98% ≤ 2 microns.

HEAT RECOVERY SYSTEM

The heat recovery system uses the heat energy that escapes while cooking the starch.

POWDER PREPARATION

In powder processing, pigment powders are processed into a suspension in GAW mixers.

SODIUM DITHIONITE SOLVENT SYSTEM

Sodium dithionite is a bleaching and reducing agent used primarily in the textile, paper and mineral industries.

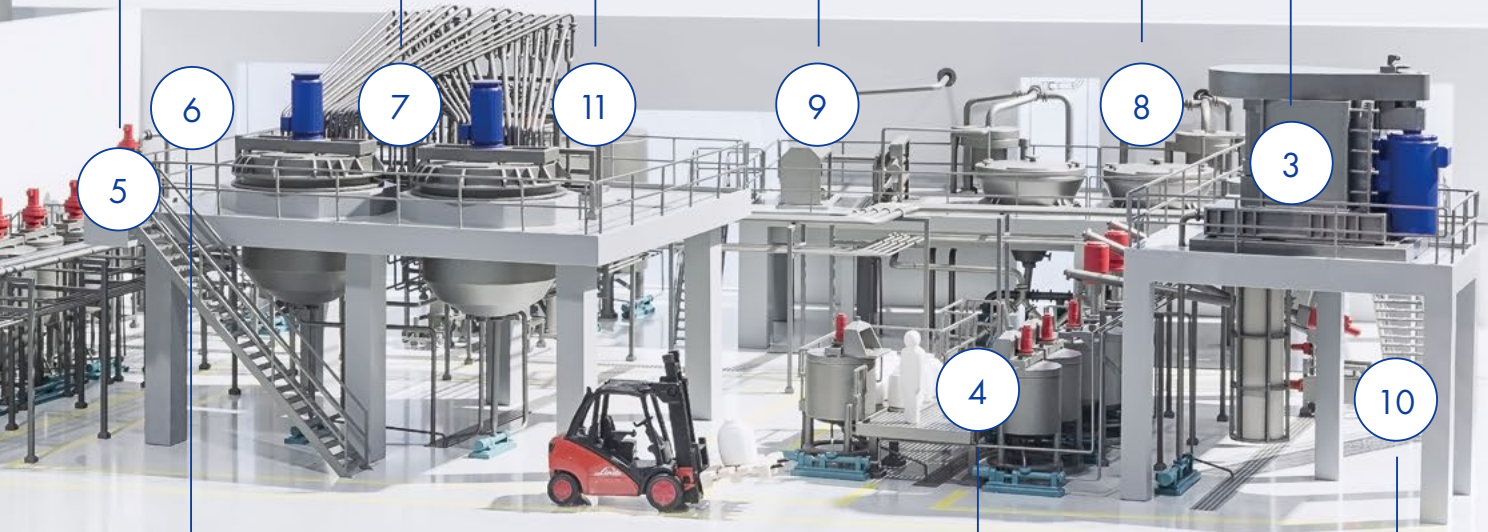



STATION 1

Supply, unloading and storage

In the area of supply, unloading and storage, media are pumped via a fine filter into the storage container. The delivery of the products is mostly by truck, railway wagon or container.

For over sixty years, GAW technologies has been engaged in the planning and turnkey construction of equipment for the handling and storage of products used in the manufacture and refining of paper and cardboard.

GAW technologies not only plans and delivers the unloading station, but also sets up the complete unloading system including all elements, as well as piping systems and automation. The complete process of unloading is carried out in fully automatic operation. Only the hose needs to be manually connected to a fixed pipe.

Operational safety, protection of personnel and the environment – these are our directives. For this reason, GAW unloading stations are state-of-the-art and meet the highest safety requirements.

Take the advantage of getting a system from a single source.

“Excellent warehouse logistics for every product.”





STATION 2

Chemicals preparation

Paper and cardboard are mainly made from fibres and fillers. In order to achieve the desired properties of the product, specific chemicals, so-called auxiliary substances, are also used.

Auxiliary substances are also referred to as additives. They are either mixed directly into the paper stock or applied to the paper at certain points on the paper machine or by a coater. There is a difference here between paper additives and process chemicals.

Paper additives are components of the finished paper. They remain mainly in paper during production and serve to give the paper necessary or desirable properties. The paper additives include sizing agents, dry and wet strength agents, pigments, dyes, optical brighteners and coating binders.

Process chemicals in turn serve to control and improve the manufacturing process as well as keep the system clean. They usually only remain in the paper in traces. The process chemicals include, among others, retention and fixative agents, flocculants and slimicides as well as defoamers and deaerators.

For an efficient production and coating process, the masterful preparation and exact dosage of the excipients are critical.

“We get the best out of every product.”





STATION 3

GCC preparation

Ground calcium carbonate (GCC) is used in papermaking as a filler as well as a coating pigment for surface finishing, whereby the ultimate fineness of the final product is achieved only by single or multi-stage milling processes using GAW Ultramill technology.

With its unparalleled vertical design, the GAW Ultramill embodies an extension of horizontal grinding ball technology, enabling the preparation of customized particle sizes.

Since the successful launch of the GAW Ultramill in 1994, customers rave about the “excellent milling technology designed to make money”.

To date, several hundred GAW Ultramills of various sizes have been installed worldwide for the dry and wet grinding of calcium carbonate. The capacities of the individual systems range from 30,000 tons to 1,000,000 tons per year. It achieves levels of fineness of 60% \leq 2 microns for filler, to 75% \leq 2 microns for the precoat, and up to 90%, 95% and 98% \leq 2 microns for the topcoat.

“Ultrafine grinding technology with the highest added value.”





STATION 4

Powder preparation

Pigments are colourants and are used in papermaking both as a filler and as a coating pigment.

The most important reason for adding filler to paper – in addition to the massive cost savings – is the improvement of the whiteness, brightness and covering capacity. Coating pigments usually consist of the same minerals as the fillers, differing from these essentially by the grain fineness.

The most common fillers and pigment minerals are ground calcium carbonate (GCC), kaolin, talc and titanium dioxide.

GAW technologies is a world-renowned specialist when it comes to total solutions for the storage, processing and dosing of these powder products, which must be handled with the utmost care.

“Excellence in
extraction, dosage
and processing.”





STATION 5

Starch preparation

The history of starch in papermaking is as old as the printed word itself. Starch is applied in various stages of the paper or board manufacturing process, be it as an additive for internal sizing, surface sizing and finishing, or in the preparation of the coating colour.

The adequate cooking of the starch is an essential requirement for any application. The preparation of the starch includes all process steps, starting with the storage of the starch powder, to the dispersion, the gelatinisation and dilution for the intended purpose.

GAW technologies starch processing systems are either supplied as standardized "skid units" or tailored to the customer's special requirements.

In recent years, the patented GAW Heat Recovery System has been successfully installed in many starch processing systems. This system makes use of the heat energy that escapes during the cooking of starch, leading to a massive energy saving in the treatment.

"Our strength,
your profits."





STATION 6

Heat recovery system

The cooking of starch is a staple element of the paper making process, no matter what kind of starch is applied. In this step, the starch is heated under pressure and by direct steam.

This is followed by relaxation in a cyclone, whereby the resulting expansion steam and heat energy contained therein is oozing unused into the atmosphere. Then the starch is stored.

So why evaporate your money? In times of climate change and the accompanying climate agreements, we cannot allow ourselves to let this heat energy escape unused into the atmosphere. That's why GAW technologies has developed a compact modular system that recovers the energy through heat exchanger. The energy of the suspension is fed back in at the inlet to the Jet Cooker, thus reducing the amount of direct steam.

The patented GAW Heat Recovery System at starch preparation lines is well established in the market, enabling energy savings of over 50% for the inactivation of the Jet Cooker.

“Protects the climate and lowers costs.”





STATION 7

Dispersing machines

Dispersing, mixing and agitating are central and quality-determining steps in process engineering. The aim of these processes is to produce uniform and homogeneous mixtures of various raw materials as intermediates or final products. The ways to achieve this goal are as different as the properties of the raw materials and the final products.

GAW dispersing machines, the heart of every coating colour kitchen, are constructed under the premises of energy efficiency, consistent and reproducible qualities, scalability, preservation of the medium and optimum process connection. In decades of reliable partnerships with key customers, the processes and technology of the dispersing aggregates have been continuously improved and developed into highly efficient dispersing systems.

The focus is always on the goal of increasing the productivity and energy efficiency of our customers' plants, minimizing their operating costs and increasing environmental protection through the development of tailor-made customized technologies.

GAW dispersing machines, from simple dispersing discs to "Variable Shear Technology" dispersing units, are already used in various industrial sectors.

"Excellent dispersion
for every application."





STATION 8

Working station

The working station is a circulatory system, via which homogenized coating colour, surface starch and other coating agents from the storage containers of the coating colour kitchen are pumped via filters into working containers. They are then pumped via further filters to the coating heads. Surplus coating colour is returned to the working tank after passing the coating unit via return lines.

In order to avoid disturbances in the coating strokes (e.g. squeegee strips), GAW deaerators are used in addition to filter systems such as the ECO-R and ECO-S. The deaerators remove air and gas bubbles from the coating colour.

Depending on the design of the coating heads, the working stations are tailored to the application and adapted with quality control instruments. A big advantage of the GAW working stations is the unique piping, which minimizes the air content of the coating mass from the outset and prevents the build-up of agglomerates.

GAW has decades of experience in all of the established coating heads – hundreds of references from around the world make clear the excellence of our work.

“Excellent symbiosis of feeding system and coating head.”

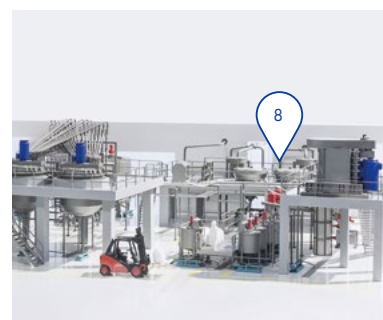

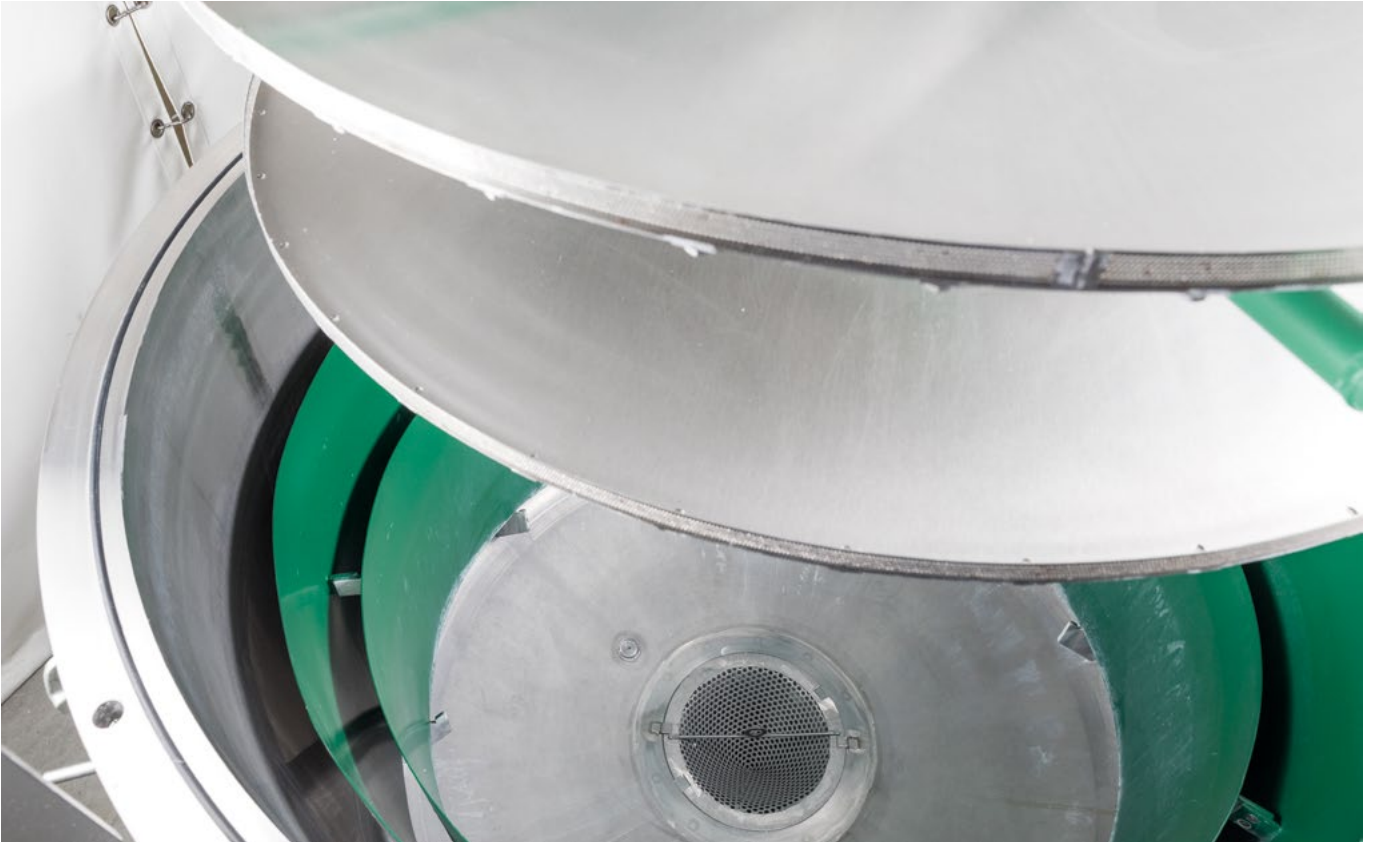

STATION 9

Deaerators

The first non-contact systems for applying coating colour and emulsions with a barrier effect on paper or cardboard had to be withdrawn from the market for a variety of reasons, but mainly due to the inefficient deaeration of the coating.

Special requirements for the coating materials for a curtain coater made it necessary to make further considerations with regard to coating colour properties and equipment requirements for coating colour bleeding. Here, the deaeration of coating colours turned out to be the essential process step in curtain coating, since air bubbles are not rubbed on paper or cardboard, but occur as imperfections in the form of oval-shaped, uncovered areas.

GAW deaerators are designed to reduce air in the coating colour to as much as 0.1%, depending on the coating colour properties and process parameters.

“Excellent deaeration,
high volume,
perfect coating.”





STATION 10

Sodium dithionite solvent system

Sodium dithionite is a bleaching and reducing agent used primarily in the textile, paper and mineral industries.

Sodium dithionite makes it possible to replace a costly raw material like pulp with a less expensive one such as recovered paper. This saves money and is better for the environment. In addition, the reduction of contaminants protects the cellulose fibres.

GAW sodium dithionite solution systems are in use worldwide, providing excellent homogenization and mixing capabilities. The systems are compact, easy to start up and offer low maintenance costs.

Under the maxim of guaranteed operational safety, the GAW sodium dithionite solution systems ensure maximum performance and minimum product losses.

“Safe.
Effective.
Compact.”





Coating colour kitchen

GAW dispersing machines, the heart of every coating colour kitchen, enable excellent dispersion for every application.

In the coating colour kitchen, the coating colours and coatings are processed by dosing and dispersing up to twenty different components in a special mixing unit according to the given recipe, based on quantity and time sequence. The coating formulations depend on the application of the paper, the paper machine, the coating process and the location.

Depending on the desired technical and optical properties of the paper quality (e.g. surface weight, density, strength, roughness, brightness, whiteness, opacity, gloss), pigments, binders and additives are used in the dispersion.

Dispersing is therefore the central, quality-determining step in coating colour preparation.

For this reason, GAW technologies has persistently improved the process and technology of its dispersing units in dependable partnerships with key customers and developed them into highly efficient dispersing systems.

The GAW dispersing machines are the heart of every coating colour kitchen and are constructed under the premises of energy efficiency, consistent and reproducible qualities, scalability, preservation of the medium and optimal process connection.

As a technology leader for coating systems, GAW technologies has decades of experience and impressive global references in the planning, supply, installation and commissioning of complete coating colour kitchens.





Coating colour recovery system

System for the recovery of pigments from wastewater containing paint.

By flushing the coating equipment and changing the production, large quantities of high-quality pigments have been lost in the production process for coated papers and board.

These effluents, contaminated with dirt and agglomerates, have only a low solids content, which makes the direct return to the process impossible.

The valuable pigments flow with the production wastewater into the sewage treatment system, where they are

separated and disposed of to landfill as so-called "paper sludge".

The operation incurs considerable costs – for the disposal of the paper sludge on the one hand and for the replacement of the lost pigments on the other.

GAW technologies has developed, patented and established a process that enables the recovery of pigments from wastewater, e.g. that found in paper mills producing coated papers.

In the GAW coating colour recovery process in paper production, 100% of the pigments are recycled back into the process, resulting in considerable potential savings for the benefit of the environment.



Less energy consumption

For example, about 70% less energy is required for reprocessing than for the grinding of a fresh pigment.

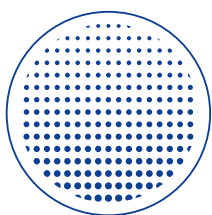

CO2 emissions completely eliminated

The CO2 emissions that result from the replacement of the lost pigment by production and transport are completely eliminated.

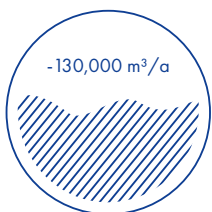

Reduction of wastewater

The amount of wastewater is considerably reduced because the separated sewage water is also returned to the process, which means less work for the wastewater treatment system.



Elimination of the pigment disposal

This also eliminates the disposal of thousands of tons of pigments that otherwise end up in the wastewater treatment system and thus in the paper sludge.



Membrane separation plants

In the paper industry, the economic benefits of membrane separation technologies come first and foremost through the optimized use of resources. Unused potential for saving water, energy and raw materials can be fully exploited by means of these technologies.

OSMO Membrane Systems, a highly specialized company within the GAW Group, develops and builds high-quality industrial membrane separation systems for various process applications. The focus here is on tailor-made special plants, filtration and reverse osmosis systems as well as solutions for water and wastewater treatment.

The membrane separation technologies applied by OSMO use the process steps of micro- and ultrafiltration, nanofiltration, reverse osmosis and membrane degasification as well as further steps for the separation of e.g. particles, viruses, bacteria and interfering molecules or ions by means of a selective separation process.

Membrane separation process and water treatment – state of the art in the paper industry

Water used in paper and pulp production contain ingredients that can be critical for high system availability in the paper process. Regulatory requirements and high wastewater costs require efficient membrane separation plants to reduce water and energy consumption.

Typical applications of OSMO systems in the paper industry:

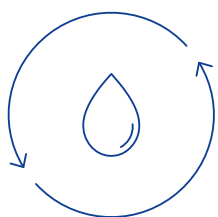

Ultrafiltration / Reverse osmosis

Reduction of freshwater requirements

Well and surface water treatment suitable for removal or reduction of solids, microorganisms, turbidity and suspended solids to supply internal consumers and as a precursor to reverse osmosis. The high-quality water quality reduces the specific consumption and increases the chemical efficiency.

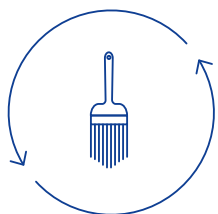

Reverse osmosis / Ion exchanger

Energy efficient water and condensate treatment

Safe production of demineralised water for boiler supply. The Factor X process step developed by OSMO can achieve yields of > 90%, which considerably reduces the wastewater quantity and improves the efficiency.

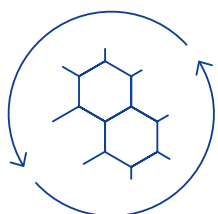

Ultrafiltration / Reverse osmosis

Reduction of wastewater volumes Reverse osmosis

Combined systems from OSMO enable the treatment and recycling of biologically contaminated wastewater from paper production. For more heavily polluted process waters, the COD load or solids can be separated by ultrafiltration, including bleaching wastewater, clear filtrate and coating colours.

Far beyond the state of the art, OSMO and GAW technologies – two excellent synergy partners within the GAW Group that have been cooperating for decades – have future technologies that improve the “energetic footprint” and achieve high operational reliability. With more than 30 years of experience, reliable and efficient process solutions are created to enable low-chemical and low-energy operation and significantly reduce costs.

Key Components „made in Austria“

ECO-R filter

Filters and sieves are indispensable components in the highly complex process of paper manufacturing and finishing. The ECO-R filter is used to filter agglomerates and contaminants from liquids, dispersions, emulsions, coating pigments and coating colours.

The medium to be filtered is conveyed through the upper intake, through the sieve blades of the strainer basket, to the outlet at the bottom of the filter. The coarse particles stick to the outside of the strainer basket.

The strainer basket is designed as a slotted mesh insert or lasered perforated basket, depending on the application. Depending on the dimensions and field of application, the ECO-R filter is equipped with a varying number of blades or brushes made of carbon or metal.

The agglomerates and contaminants that adhere to the sieve basket are cleaned by the blades or brushes, conveyed to the filter bottom and introduced into the reject space. Optionally, the reject space can be designed as a lock, whereby the discharge of the agglomerates and impurities during continuous operation is possible.

The displacement body of the ECO-R filter reduces the working volume to a minimum and allows optimum flow conditions. The dimensioning of the filter is based on the flow rate, type of impurities and the viscosity and abrasiveness of the medium. Several filters can be interconnected to achieve necessary capacities.

ADVANTAGES

- > Compact design with high throughput
- > Screen finenesses 50 µm and higher
- > Easy disassembly of the strainer basket
- > Easy cleaning
- > Backwashing / rinsing of the filter with a small amount of water during thorough cleaning
- > Easy handling during service work
- > Minimal production losses





SIZES

The ECO-R filter is available in four sizes:

- > Ø 167
- > Ø 215
- > Ø 301
- > Ø 470

GENERAL TECHNICAL DATA

| Size | Ø 167 | Ø 215 | Ø 301 | Ø 470 |
|-------------------------|-------|-------|-------|--------|
| Medium capacity | 20l | 37.4l | 52.5l | 106.8l |
| Weight | 90kg | 120kg | 220kg | 380kg |
| Max. operating pressure | 10bar | 10bar | 10bar | 10bar |

ECO-S filter

The ECO-S filter is used to filter agglomerates and contaminants from liquids, dispersions, emulsions, coating pigments and coating colours.

The pressure filter system is composed of static filter elements that combine into one unit. The number of filter elements per filter station varies depending on the intended flow rate. A filter element consists of a filter housing and a filter unit with mesh fabric.

Developed for continuous operation, the ECO-S filter station is a closed filter system. The filter system has a function for recovering the residual medium remaining in the individual filter elements. In this way, the residual medium is recycled before the rinse and completely returned to the process.

The cleaning process of the filter station takes place in continuous operation. The dirty filter elements are temporarily switched off and backwashed. The ECO-S filter is sometimes used for cleaning fresh process water. In this case, the dimensioning of the single filter is tuned to the flow rate of the pump.

ADVANTAGES

- › Continuous operation
- › Low medium volume
- › Screen finenesses 50 µm and higher
- › Closed system
- › Compact design with high throughput
- › Backwashing / rinsing of the filter with a small amount of water during thorough cleaning
- › Highest-possible filtration





SIZES

The ECO-S filter station is available in three sizes:

- › Ø 50x200 / 50x300
- › Ø 95x445 / Ø 95x545 / Ø 95x645
- › Ø 120x645
- › Ø 160x700

GENERAL TECHNICAL DATA

| Size | Ø50x200 Ø50x300 | Ø95x445 Ø95x545 Ø95x645 | Ø120x645 | Ø160x700 |
|-------------------------|--------------------|-------------------------------|----------|----------|
| Medium capacity | 1.33l 1.77l | 6.64l 7.69l 8.71l | 10.84l | 18.69l |
| Weight | 15 kg | 20 kg | 30 kg | 40 kg |
| Max. operating pressure | 10 bar | 10 bar | 10 bar | 10 bar |

Dispersing machines

GAW dispersing machines, the heart of every coating colour kitchen, are constructed under the premises of energy efficiency, consistent and reproducible qualities, scalability, preservation of the medium and optimum process connection.

In decades of reliable partnerships with key customers, the processes and technology of the dispersing aggregates have been continuously improved and developed into highly efficient dispersing systems.

GAW dispersing machines enable the preparation of homogeneous dispersions and emulsions with desired viscosities, solids contents and rheological properties.

01 HOMOGENIZATION

Two or more product phases are distributed in such a way that exactly the same distribution of components occurs in each subset.



08 FOAMING

Foaming is the introduction and even distribution of air / gas in a liquid.

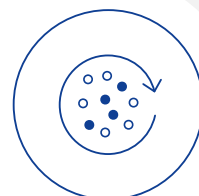
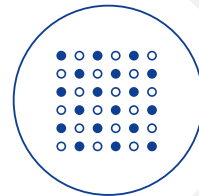

07 ELUTRIATION

Sedimented solids are fluidized by turbulence to restore the mixture.

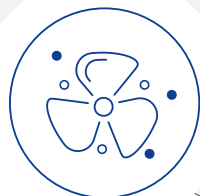

06 REACTION ACCELERATION

The mechanical action of the rotor / stator accelerates chemical reactions (e.g. for foamed products).

02 EMULSIFICATION

Two non-miscible liquids, such as a hydrophobic and a hydrophilic phase, are permanently mixed together.



03 SUSPENSION

The distribution of a non-soluble solid in a liquid.



04 SOLVING

Here, soluble substances are to be introduced into a liquid.

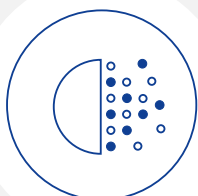

05 DEAGGLOMERATION

Dry particles (e.g. in powder) clump to form agglomerates when mixed with liquids. These agglomerates are broken up mechanically during dispersion.

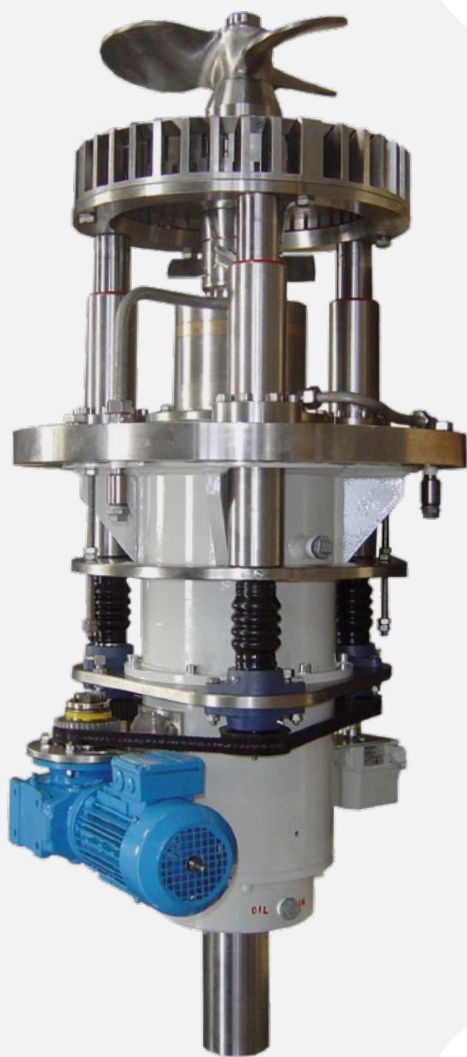

Top-drive system

GAW dispersing machines with top-drive systems are designed under the premises of energy efficiency, consistent and reproducible qualities, scalability, preservation of the medium and optimum process connection.

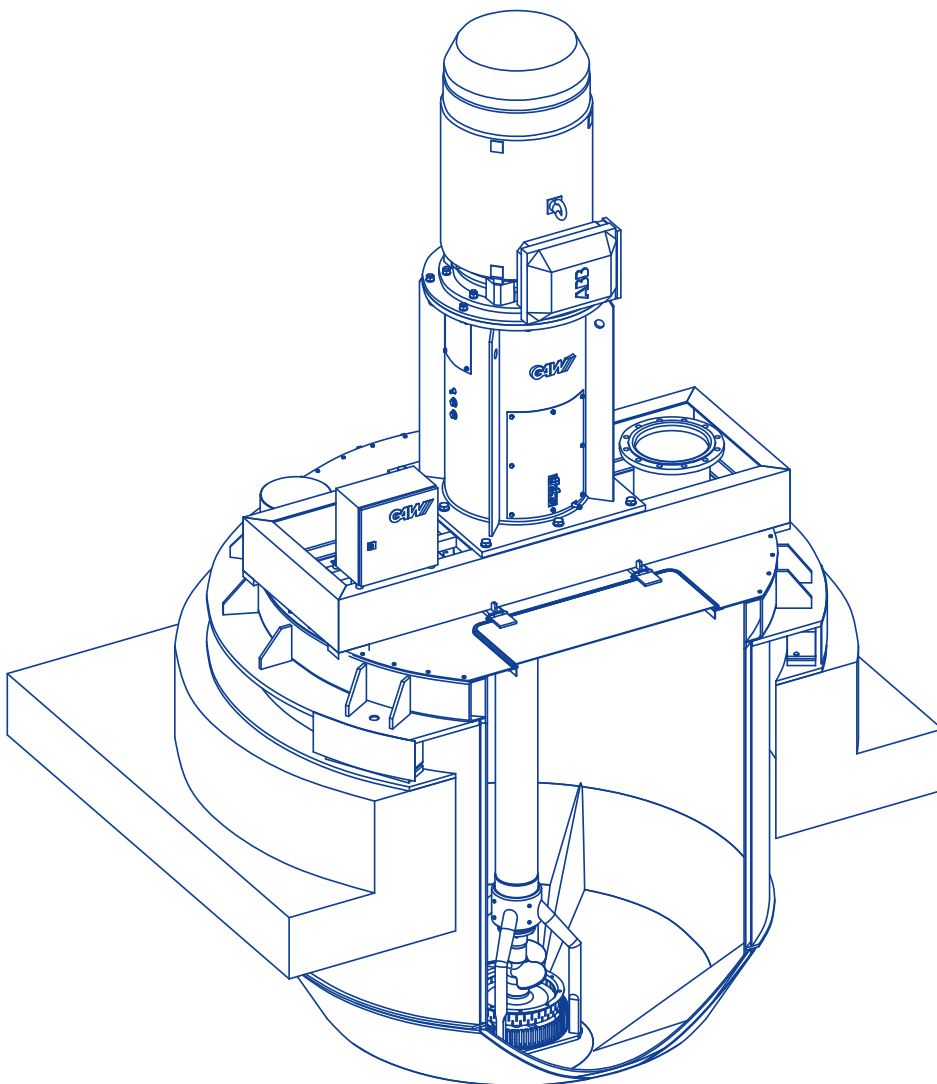



Dispersing disc

The classic dispersing disc is ideal for simple dispersing and homogenizing tasks. The design of the toothed disc, the number of revolutions, and the positioning of the components within the containers, which are adapted to the respective application, ensure optimum results.

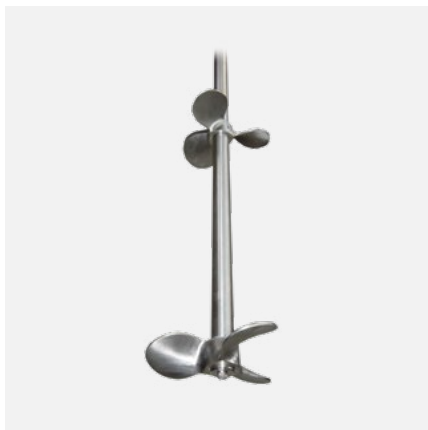

Rotor-standard

GAW's top drive rotor-standard dispersing machines enable the gentle preparation of simple product formulations. For more complex applications, these dispersing machines can easily be retrofitted to the patented Combined Dispersing System (CDS).



Rotor-CDS

The patented GAW Combined Dispersing System enables the user to disperse difficult-to-process products at a high solids content, allowing for tremendous flexibility when it comes to recipe formulation. The CDS optimizes the entry of the dry product, reduces the use of dispersant and massively reduces energy consumption.



Rotor-stator-standard

GAW's rotor-stator-standard dispersing machines are based on the basic principle of kinetic energy. The use of a rotor-stator unit ensures the forced dispersion of the product to be processed. The top and bottom propellers assist in delivering the media to the rotor-stator system, thereby providing optimum circulation in the dispersing tank.



Rotor-stator-VST

The GAW Variable Shear Technology (VST) combines the advantages of the rotor-stator standard systems and dispersing toothed discs. VST is based on the stepless adjustment of the rotor-stator overlap during operation. This allows the user to set an optimal ratio between rotation and shear for all applications.

ADVANTAGES

- › No mechanical seals
- › Little need for space
- › No need for sealing water
- › Easy handling during service work
- › No oil for lubrication or cooling
- › Design of dispersion tank
- › Reduction of operation costs

Bottom-drive system

GAW bottom-drive dispersing machines are designed in a suspended or chassis type design.

Here, the design of the containers of the bottom-drive dispersing machines is adapted to the respective case of application. Options such as dosing monitoring, process temperature control via double-walled containers and connection of the GAW Quality Loop enable customers to achieve the desired qualities in a targeted manner.

The pneumatic flow breaker influences the circulation. It is controlled via pneumatic cylinder. In the lower position it ensures more efficient dispersion, in the upper position increased circulation in the container.

GAW bottom-drive dispersing machines are available in the low shear standard, high shear standard or Variable Shear Technology (VST) adjustment units.

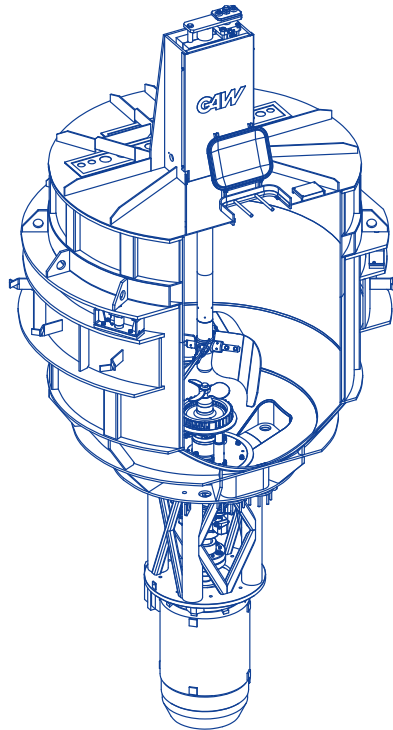

Hanging / suspended type

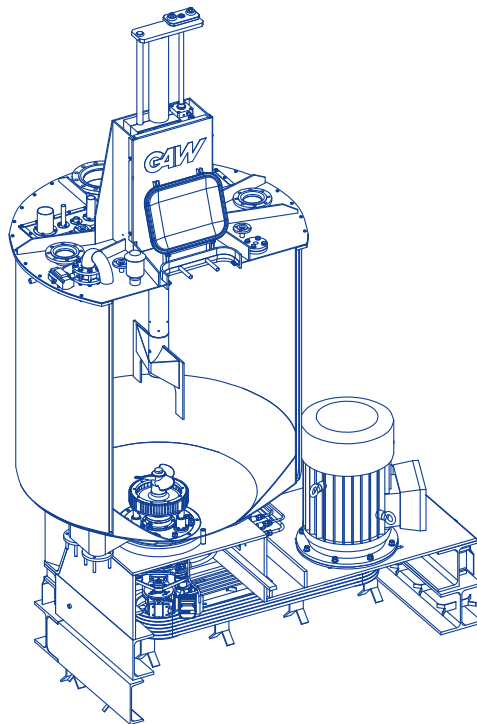

Standing / chassis type

The pneumatic flow breaker is controlled via a pneumatic cylinder. In the lower position it ensures more efficient dispersion, in the upper position increased circulation in the container.



BENEFITS OF GAW
BOTTOM-DRIVE
DISPERSING MACHINES

- > Optimal energy conversion and high efficiency
- > Short batch times
- > Easy retrofitting of the dispersing unit
- > Processing of high solids contents
- > No air in the coating colour
- > No vortex

SIZES

- > DA 60
- > DA 65
- > DA 75
- > DA 90
- > DA 100



Low shear standard



High shear standard



Variable Shear Technology (VST)



DISPERSING

ContiMixer

The GAW ContiMixer is a continuous dispersing machine in which a large number of raw materials are processed into a coating mass.

In its maximum size CC750, the Conti-Mixer enables a throughput of up to 35,000 litres per hour, around the clock. Its special division into four different mixing zones prevents the heating of the coating medium and enables correspondingly high solids contents and viscosities. Since the ContiMixer is a completely closed system, impurities are eliminated and consistent colour quality is ensured.

Compared to the batch process, the continuous processing of coating compounds offers enormous advantages for the manufacturer.

Generally, the total cost of operation of the system is considerably reduced. Connected load and energy consumption are reduced by up to 75%, coating colour losses during recipe changes are avoided, and water consumption and maintenance costs are drastically reduced.

ADVANTAGES

- › Dispersing and Mixing in four zones (from high to low shear)
- › Little need for space
- › Compact design with high throughput
- › Fast paper grade change
- › No coating colour losses during recipe change

The GAW ContiMixer offers enormous advantages for the continuous processing of coating compounds and ensures a massive reduction of the total cost of operation.



Agitators, mixing systems, special apparatus construction



GAW technologies offers individually tailored agitating and mixing systems and systems for a wide range of process applications, including slurry stations, starch processing systems and sewage collection pits.



The optimized procedural and control engineering design guarantees maximum cost-effectiveness. Different stirring and mixing elements are used, depending on the job. The dimensioning and design of the mixing elements is adapted to the size and shape of the tanks, the chemical-physical properties of the process medium and the process task.

For the task of agitating and circulating, GAW technologies has an extensive product range of tanks and special apparatuses with agitators for targeted individual solutions.

The agitating systems are used to prevent sedimentation in a container and to maintain a homogeneous mixture. It is essential to keep the medium continuously in motion in its entirety in order to keep the quality of the process medium constant over long periods of time.

Depending on the application, GAW uses vertical, horizontal or inclined stirrers with optimally matched stirrer elements. Special care is taken in the design of agitators in special apparatus construction, where the process media are dissolved or cooked and a variety of chemical reactions take place.

In addition to the optimal design of containers and stirrers, GAW technologies pays special attention to the sealing of the stirrers. Due to the prevailing processes and required safety regulations, these often require a special design.

APPLICATIONS

- > Agitators for storage containers
- > Agitators for small and medium sized containers
- > Agitators for targeted process control

ADVANTAGES

- > Optimal energy conversion
- > Compact, low-maintenance design
- > No deposits due to construction and design
- > Individual adaptation of the stirring elements
- > Optimal adjustment to the manufacturing process



MILLING

GAW Ultramill

The vertical GAW Ultramill is unique as an extension of conventional horizontal grinding ball technology. It enables the treatment of particles of the desired order of magnitude adapted to the application.

The agitator ball mill is made of steel. The parts that are particularly exposed to abrasion are furnished with highly resistant alloys. The grinding chamber, which is encased in cooling water, is divided into different sections for easy inspection and maintenance.

The grinding discs are built in an exclusive GAW design. They are configured in a modular concept to enable different end-product characteristics.

All operating parts (e.g. grinding discs, spacers, ball separators and the intake rotor) have been designed to slide over the shaft in any required configuration. This feature provides great flexibility in design, optimizes energy consumption, milling efficiency and maintenance costs.

Depending on the design and intended application, the mill is filled with grinding media of adequate diameter. The product to be ground is introduced through the distributor at the bottom of the mill.

For this purpose, a controlled pump with adjustable speed is used, regulated by a mass flow meter (Coriolis principle). Performance, particle size distribution, fineness and the grinding speed of the system are managed by automated production control.

Immediately after entering the mill via the distributor at the bottom, the product is homogeneously dispersed by the intake rotor and the bottom grinding disc.

The agitator ball mill drive is equipped with a frequency converter. As a result,

the rotational speed and configuration of the grinding discs can be optimized. As soon as the product is dispersed, the product and grinding balls rise in a spiral-like rotary motion to the height of the agitator ball mill.

The spiralling, upward movement provides a zone of high pressure while a low-pressure zone forms around the shaft.

The strong vortex movement prevents the exit of the grinding balls because they move along the shaft, spiralling downward.

The rotation of the grinding media takes place in a closed circuit. In combination with the tremendous working speed, this achieves the ultimate grinding efficiency.

GAW Ultramills grind calcium carbonate into fillers and ultrafine coating pigment. It achieves fineness from 60% ≤ 2 micron up to 98% ≤ 2 micron. Hundreds of installed agitator mills in GCC grinding plants worldwide ensure system capacities of 30,000 tons up to 1,000,000 tons per year.

ADVANTAGES

- › Low energy consumption
- › Efficient control of particle size
- › No liquid leakage
- › High grinding efficiency
- › Low maintenance costs
- › No filtration problems
- › Standard IEC drives
- › Little need for space



GAW Airvent

The GAW Airvent is a cyclone deaerator used for deaerating media, dispersions, emulsions and coating colours.

The GAW Airvent uses the centrifugal force created by the tangential inlet and rotational movement of the fluid inside the cyclone. The part of the medium with a high number of air bubbles (and thus low density) forms into a core and is withdrawn upwards via a central vent nozzle. The part of the medium with lower air content (and thus higher density) migrates to the outside and is discharged through the bottom of the cyclone.

The GAW Airvent consists of a variable number of cyclones, which can be switched on or off with ball valves according to the respective coating colour consumption. The cyclones are constructed with inlet and outlet pipes on

a frame. Each cyclone has a separate channel valve for cleaning and emptying.

Depending on the volume flow or the proportion of air in the medium, the necessary number of cyclones can be switched on or off during operation. The optimum setting is made via differential pressure measurement; coriolis or radiometric measuring instruments on the drainpipe allow efficient operation of the GAW Airvent.





ADVANTAGES

- › Flow-optimized design
- › Modular construction
- › No deposits
- › Easy handling during service work

Based on the proven, modular GAW design, the Airvent reduces air content in the coating by up to 7%.

GAW Airvac



The GAW Airvac is a vacuum deaerator used for deaerating media, dispersions, emulsions and coating colours. It removes air from the coating compound and enables a bubble-free coating application on the paper.

The GAW Airvac, a true masterpiece, has been specially developed for air-sensitive applications. For a curtain coater, it is part of the GAW working station.

Specially developed for the needs of the paper and board industry, the GAW Airvac combines all the common basic deaeration methods.

The vacuum deaerator consists of the main components vacuum container, motor, coating colour distribution system and centrifugal discs. The medium to be deaerated is distributed in parallel via three separate connections on the rotating centrifugal discs. These throw the coating colour radially against a double wall system, where it drains off and is collected in the container bottom.

In this process, fine drops of paint are formed, which favour the deaeration.

Negative pressure in the vacuum container causes the air bubbles contained in the paint droplets to expand and burst. The released air is extracted by the vacuum system.

The vacuum deaerator is a basic part of the working stations for curtain coater applications.

If the bubble-free quantity of coating colours required on the coating unit exceeds the nominal colour flow rate of the deaerator, several deaerators are interconnected.

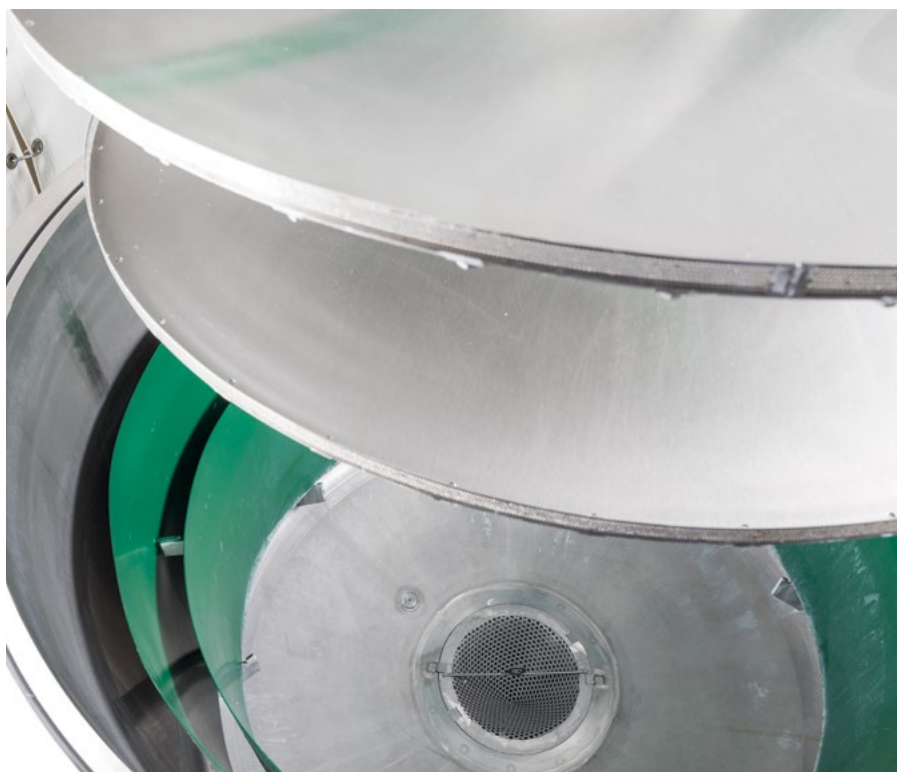
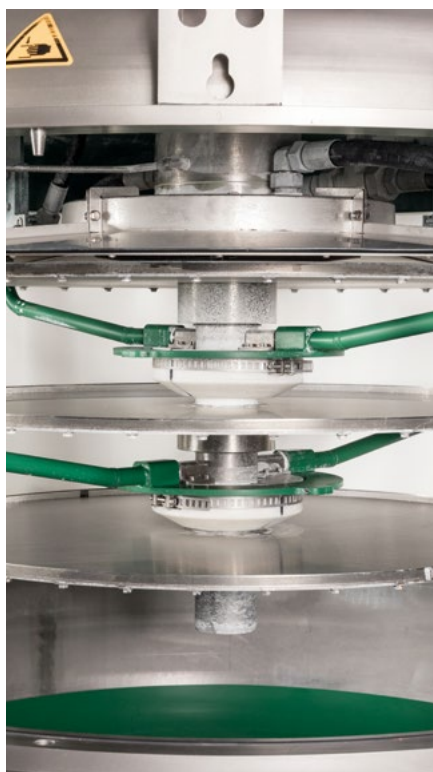

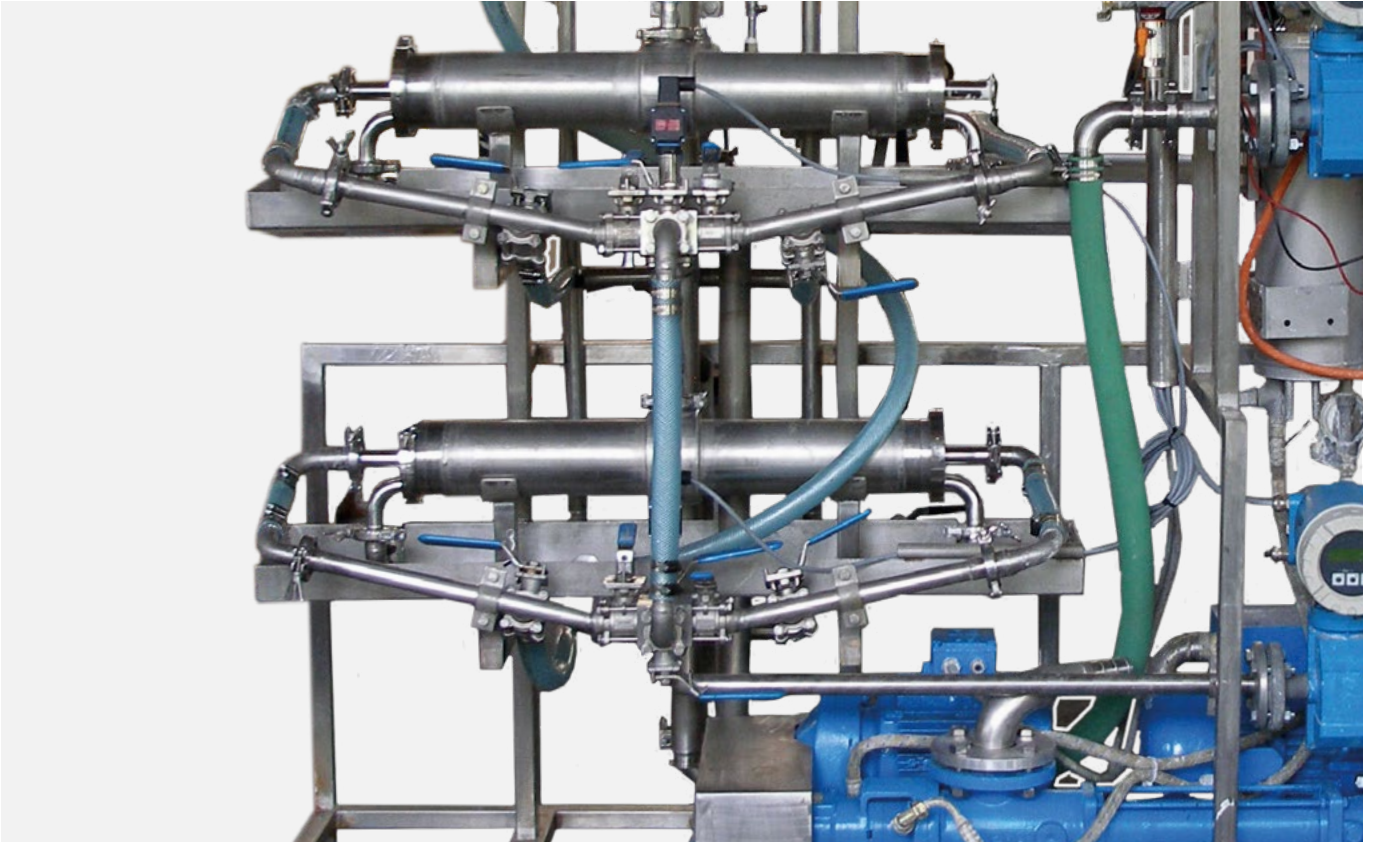

DEAERATING

GAW Airmem

The GAW Airmem membrane deaerator is suitable for venting all liquid or paste-like spreading media used for coating, inkjets, dispersions, developer solutions, emulsions and oils.



Finishing processes for paper or cardboard webs are significantly determined by the homogeneity of the coating composition to be applied. In order to ensure a uniform coating of the material web, the application layer must not show any imperfections.

In this case, depending on the respective application unit, the air content of the coating composition is crucial. Very small air bubbles in particular are a big challenge for the manufacturers. In the continuous operation of a curtain coater, a completely deaerated medium is an essential prerequisite.

The GAW air membrane deaerator is the only efficient solution. Despite minimal space requirements, there is an immensely large surface area available for the efficient deaeration of the spreading media. The medium to be deaerated is circulated around hollow fibre tubes of polyolefin, which are incorporated into a fabric-like array. During this process, no shearing acts on the coating mass, so that it retains its chemical-physical values achieved in the preparation.

Since its foundation, AutomationX has been operating in an excellent partnership with GAW technologies. Today, the company is already implementing total solutions in the pulp & paper, food, petrochemical, energy and infrastructure sectors.





LABORATORY EQUIPMENT

Laboratory dispersion equipment

Excellent, reproducible results!

GAW technologies has been developing mixers for homogenizing liquids for over 40 years. Extending beyond our traditional business – the paper and board industry – our developments are now used in a variety of industries that employ mixing technology.

In research and development, GAW technologies relies on a synergetic network of know-how within the group of companies as well as on cooperation with national and international universities, colleges, research institutes and in particular on joint developments with their customers.

Thanks to many years of development partnerships, processes and key components are constantly being improved, the knowledge is integrated globally and our key customers are supported worldwide to create innovative solutions in the dispersing technology.

Our GAW laboratory dispersers were perfected in the same way. These offer

- > Volume from 5 to 50 l
- > Motor performance from 5.5 to 7.5 kW
- > Stepless speed control via frequency converter
- > Speeds up to 5,000 rpm
- > Easily exchanged dispersing units
- > Propeller, turbine wheel and rotor-stator equipment
- > Standard rotor-stator design with 1 row of teeth
- > Cooling and heating jacket
- > Single-acting mechanical seal with sealing water device

Quality loop

In order to be able to achieve the desired quality of the coating compound in the coating process – which is demanding technologically – the relevant parameters must be kept within narrow limits.

The complete system, including all gauges, peripherals (e.g. pumps, filters or irrigation), is packaged in a compact and mobile unit to allow flexible deployment in different locations.

The modular measuring system GAW Quality Loop enables the continuous monitoring of the parameters and ensures the uniform and excellent quality of the coating compound.

MEASURED PARAMETERS

- › Solids content
- › Viscosity
- › High shear viscosity / shear rate
- › pH value
- › Temperature
- › Density
- › Air content
- › Mass flow
- › Volume flow
- › Redox potential

ADVANTAGES

- › Continuous monitoring and recording
- › Data transfer via ProfiBus
- › Fully automatic measuring, cleaning and calibration processes
- › Real-time measurement and traceability of quality features
- › Easy operation
- › Reduction of quality control costs (laboratory)

PERFORMANCE

- › Optimization of raw material batches
- › Precise adjustment of the additives
- › Significant prevention of reject rates



automationX[®]

The worldwide established process control system automationX[®] by the homonymous company is the product of over thirty years of experience in project execution and is continuously improved and advanced in development partnerships with key customers in the paper industry.



This scalable, hardware-independent, modular Distributed Control System (DCS) enables the customer-optimized implementation of simple, single-user solutions right through to system-wide distributed systems in which the entire breadth of automation and control technology can be configured with a single tool.

automationX[®] is not limited to control and visualization but includes a number of integrable modules such as Advanced Process Control (APC) solutions, batch and continuous operation production management systems (MES) and energy management systems.

The scope of services of AutomationX includes concept development, project

planning including customer-specific developments, complete implementation of system technology including network technology and interfaces, electrical engineering with IO level including control cabinet construction, commissioning and system optimization, customer training, follow-up, maintenance and 24 / 7 standby service.

AutomationX and GAW technologies, two strong partners within the GAW Group, have already automated and optimized hundreds of plants in the pulp and paper industry worldwide.

Since its foundation, AutomationX has been operating in an excellent partnership with GAW technologies. Today, the company is already implementing total solutions in the pulp & paper, food, production, building materials and infrastructure sectors.

automationX[®] process control system
for processing systems –
open, adaptable, efficient, modular.

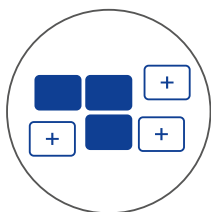

Open

Industrial plants in the paper industry are usually designed for decades of operation. Therefore, it is necessary to couple different subsystems and field components with different interfaces to a process control technology. AutomationX has implemented a large number of interfaces in their automationX[®] system, which means they can combine the most diverse generations of components on a single control system. A consistent system configuration from the operating stand to the control as well as the scalability from a single-user solution to highly redundant cluster solutions round out the performance profile.

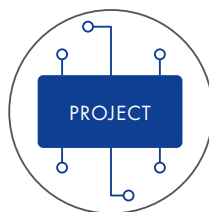

Adaptable

Experience has shown that, in the course of implementing a project, there are often a number of adjustments and changes in comparison to the originally designed variant. automationX[®] offers the opportunity to influence all mechanisms of the automation system comprehensively. In this way, changes and adjustments to the project can be carried out quickly, simply and without interruption.

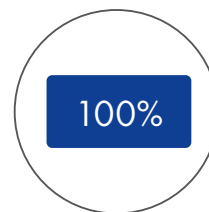

Efficient

An experienced team and a network of selected system integrators ensure swift and professional implementation of the projects. Thanks to this structure, AutomationX offers the best possible training, 24/7 support and tailor-made, optimal follow-up support.



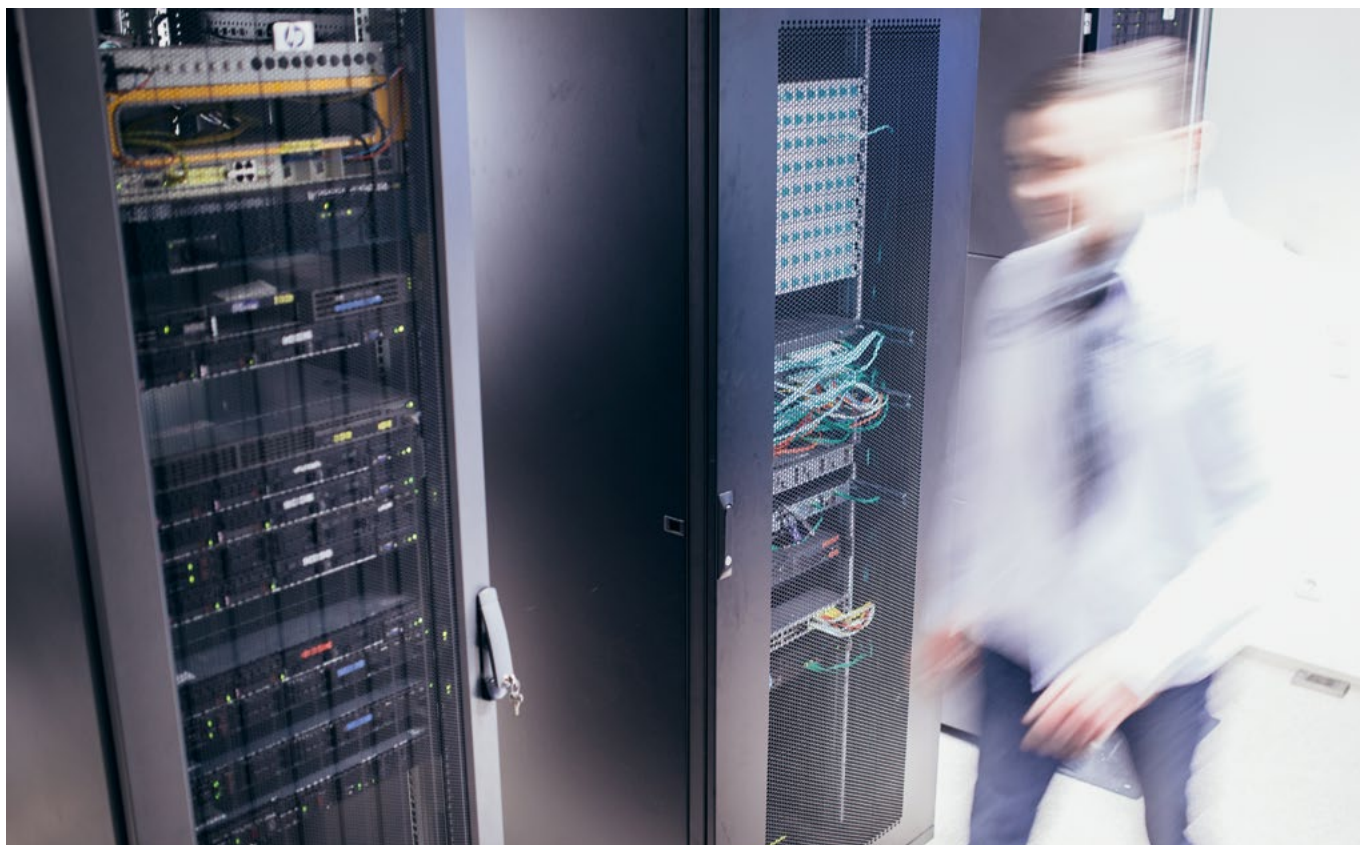

AUTOMATION

Advanced process control-solutions (APC)

Use the full potential of your system.

Your goal as an operator is to exploit the full potential of your production plant. AutomationX® supports you without the need to invest in expensive conversions. Intelligent model-based simulations and regulations enable you to break new ground.

AutomationX's advanced process control (APC) solutions are systems that provide both convenient and efficient analysis of process data as well as intelligent control and regulation of the process based on the data obtained. In doing

so, AutomationX works with historical data and the process know-how of your operating team, represented in mathematical models.

These APC solutions can react much more quickly to disturbances, thus reducing or completely eliminating variances in the process.

The focus of APC solutions from AutomationX is on the complete digitization of individual system components through to system-wide production optimization.

In combination with other AutomationX modules, such as production management (MES), indispensable synergy effects are created.

The expanded e-solutions of AutomationX® contain defined guarantee values that you will achieve with the most modern technology!

The GAW ContiMixer offers enormous advantages for the continuous processing of coating compounds and ensures a massive reduction of the total cost of operation.

The APC classic has been enhanced with e(nhanced) modules

Enhanced Model Predictive Control (eMPC)-solutions

eMPC solutions optimize individual-process sections in a targeted manner. AutomationX uses the classic advance process control (APC) approach. The optimization of individual process stages in consideration of all conditions ensure high potential savings (raw materials, additives etc.) and lead to the maximization of the desired quality.

ePO (Enhanced Process Optimizer)-solutions

ePO solutions enable fully networked process optimization across all process stages (time and energy). Hybrid models from physics and history, networked with all relevant systems (ERP, PLS, QCS, etc.) enable a combination of time and energy optimization (balanced manufacturing - BaMa) compared to conventional APS and PPS. The factory-wide simulation or optimization is made possible

by the BaMa Tool Chain. Hybrid Discrete Event System (DEVS) mechanisms are the foundation of AutomationX tools. They allow you to link a variety of different models together to model your systems.

ePM (enhanced Paper Machine)-solutions

ePM solutions enable the cost-effective production of all types of paper and quick and precise grade changes. The substantial savings are achieved by maximizing the filler content, which is to be entered depending on the availability of the rejects and / or the filler. The stepless weighting between quality and cost-optimal operating style allows the flexible adaptation to the product requirements.

The continuous adjustment of filler, rejects and chemical additives reduces the variance of ash in the base paper as well as the fluctuations in the retention system. →

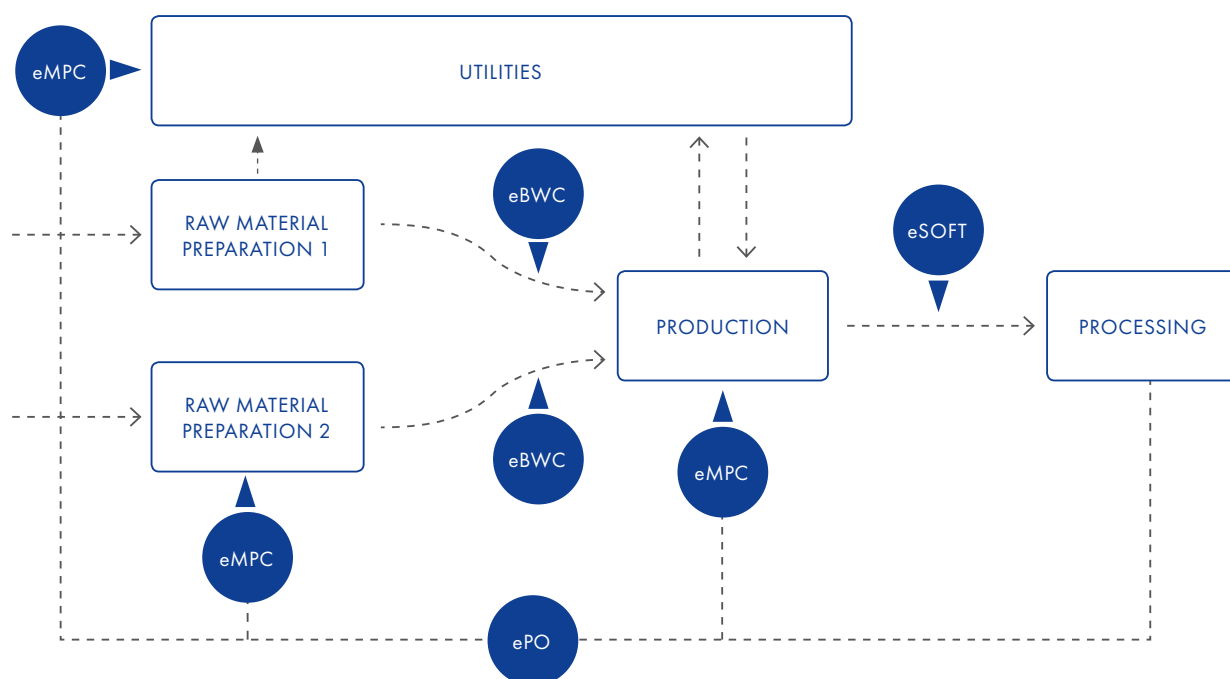

—> This allows the user to raise the ash target values for all paper types according to the physical potential. In combination with the novel hybrid eMPC technology, it is possible to map discrete process states and continuous dynamic process behaviour in a common process model and thus decisively improve the control behaviour.

ePULP (enhanced pulp) solutions

The ePULP system monitors the bleach effect minute by minute and adjusts the use of chemicals continuously. This achieves more stable process conditions (e.g. pH value) as well as a significantly reduced variance of the final quality, without the operating team having to deal with the process changes. The operating team can concentrate exclusively on system operation. Avoiding over-quality brings immediate savings on chemicals. The lower variance reduces the target and average values in the area of white/finished fabric by several

tenths of a percentage point and the total bleaching agent input is optimally distributed over all stages. In addition to the economic effects, the ePULP solution thus leads to demonstrable relief for the operating team and the environment.

eTMP (enhanced Thermo Mechanical Pulp)-solutions

eTMP solutions ensure cost-optimized refining operation. Process models for each refining stage bring about local optimization. Missing quality online measurements are displayed in the form of soft sensors. A higher-level optimization module enables energy savings through load shifting. As a result, energy-efficient system components can be used much better. Minute-by-minute calculation cycles allow the constant adjustment of the necessary target values. In addition, the daily forecast of energy prices can be taken into account in production. Smart optimization algorithms skilfully exploit tank levels to

run refiner facilities at the lowest energy cost.

eDIP (enhanced Deinked Pulp)-solutions

The implementation of an eDIP solution in the area of the deinking system creates the basis for a process management that counteracts raw material fluctuations and process variations immediately and with suitable means, stabilizes quality, saves costs and increases the yield. In addition to the control of the individual stages (dissolving drums, pre-flotation, post-flotation, bleaching stages), a higher-level optimizer enables total regulation across all stages. As a result, the goal of the most cost-effective DIP substance treatment can be achieved while adhering to the specified quality objectives with regard to ash content and whiteness.

eDRY (enhanced Drying)-solutions

Drying processes in the paper industry require about 70% of the total energy requirement. This is reason enough to invest in the reduction of steam consumption. eDRY reduces steam consumption without the need for your operating team to intervene. Hybrid process models (empirical and physical) depict the drying process with all relevant ancillary processes. The result is a virtual representation of the real paper machine. A closed-loop operation of the real paper machine makes it possible to optimize the steam consumption in the dryer group. The key to success is the calculated dry content after the press section. With the additional application of the ePM solution, a substantial reduction in steam consumption can be achieved without disregarding quality specifications.



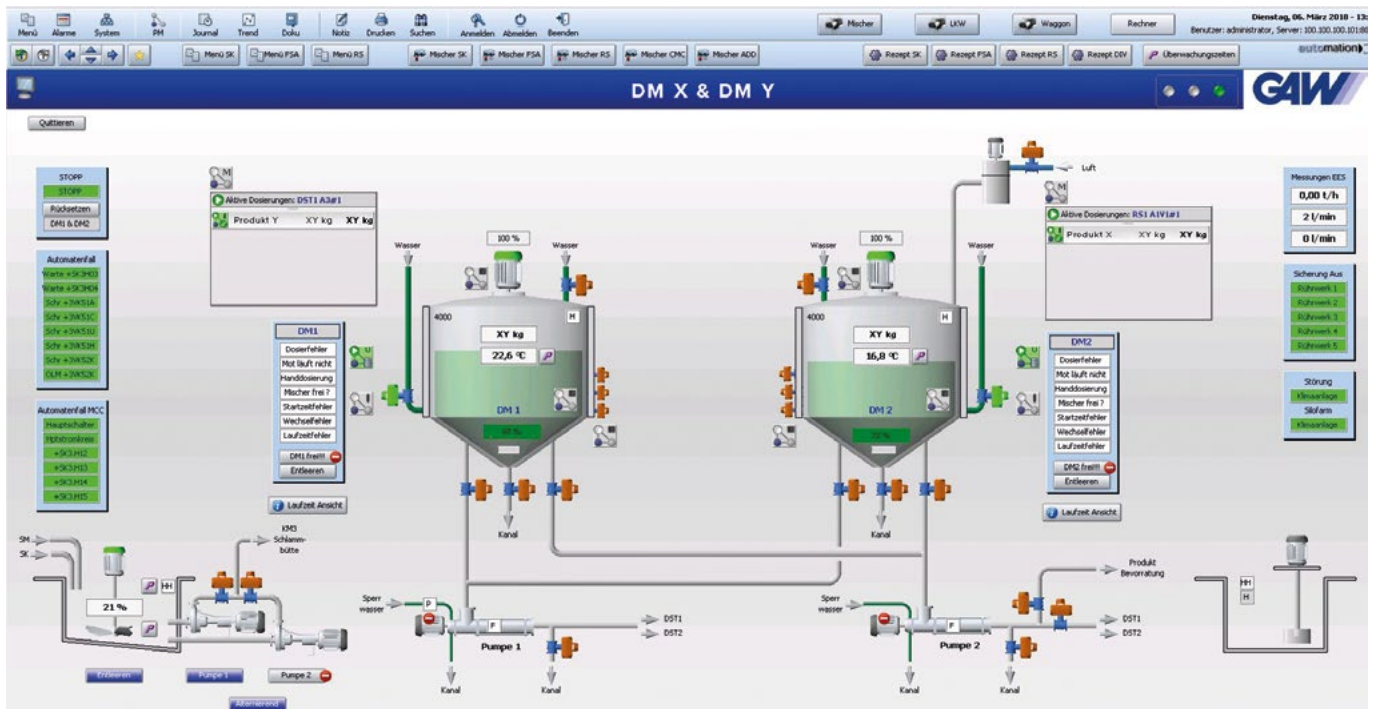

AUTOMATION

Production management systems for batch and continuous operation

Manufacturing Execution Systems (MES)

AutomationX offers a range of components for planning, visualizing, monitoring and analysing your production. The production management module is based on the ANSI/ISA S88/95 standard and has all the MES functionalities. The individual components are mapped in object-oriented technology libraries and connected to the process peripherals via various interfaces. This creates a transparent production system that schedules the relevant order data, optimizes and executes sequences, and records, visualizes and analyses performance and quality data.

The automationX[®] production management system enables

- › Product and batch tracking
- › Process modelling, planning, execution
- › Trending, statistics, journal
- › Resource management (warehouse management, material, personnel)
- › Communication to local controllers and data buffering
- › Control of marking systems
- › Performance and quality analyses (VDI 3423, OEE)
- › Reporting
- › Operating and machine data acquisition
- › Alarm management
- › ERP interface
- › Data archiving and recovery

Synergy Projects

SAPPI, GAW technologies, AutomationX



SAPPI and GAW technologies have had an excellent partnership for decades.

As part of the successful conversion of the largest and most versatile paper machine in the world to produce one-side coated and MGBK (Machine Glazed Bleached Kraft) coated speciality papers, AutomationX has now integrated its MES solution for coating colour production management throughout the facility.

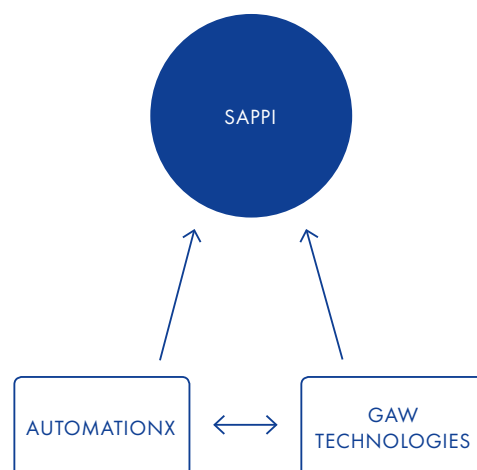

The initial situation – coating colour losses and their related costs

The number of coating units on modern paper machines and the frequency of paper grade changes greatly increase the requirements for coating colour preparation. Fluctuations in production due to changes in the recipe lead to coating colour excesses and in turn to related expenses for reprocessing and intermediate storage. This environmental impact and waste of resources was halted by the introduction of an MES solution for automatic coating colour production management .

The system-wide CCPM solution comes full circle.

The Coating Colour Production Management (CCPM) solution from AutomationX closes the circle between the various process control systems of the paper and coating machines, the software solutions for resource planning and the quality information systems.

The CCPM ensures mill-wide production planning of the coating colour preparation on the basis of the higher-level paper production planning as well as for the continuous adaptation according to the ongoing production.

GAW technologies expertly tackled the tailor-made technological solution for the conversion of the coating colour preparation that meets the high quality standards of SAPPI. →

Excellent partnership between SAPPI, AutomationX and GAW

—> The smooth interaction of coating colour preparation and coating colour production management now enables SAPPI to quickly change the coating colours to produce a wide range of paper and packaging products. These include coated papers for flexible packaging, premium SBS cardboard, top liners for high-quality corrugated packaging, label papers for wet adhesive applications, glasses, banderols and wrappings, and, last but not least, papers based on silicone as carrier material for self-adhesive products like plotter films and stickers.

The validated evaluations by the end customer a few months after commissioning show a savings from coating colour losses that exceed expectation even by far and a significant reduction in the employee workload.

The original situation

1 central coating colour kitchen, 1 employee, 4 colour mixers supply 8 coating units, the employee was under constant stress.

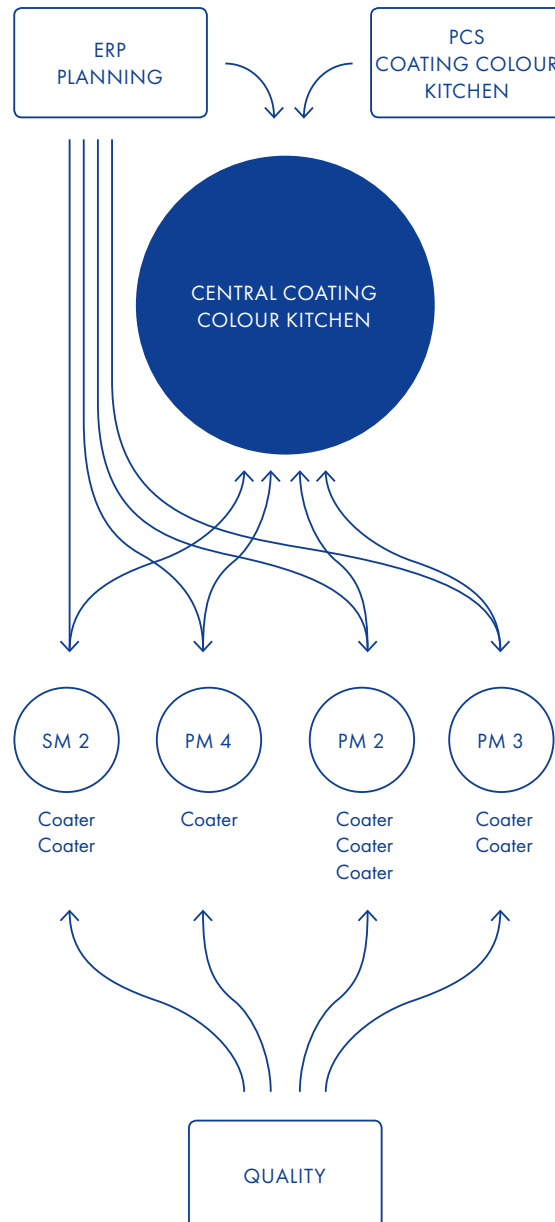

ROI → 4 months after introduction

The solution

The circle closes through the CCPM of AutomationX.

The functional plan

The CCPM ensures factory-wide production planning of coating colour preparation based on the higher-level enterprise resource planning (ERP).

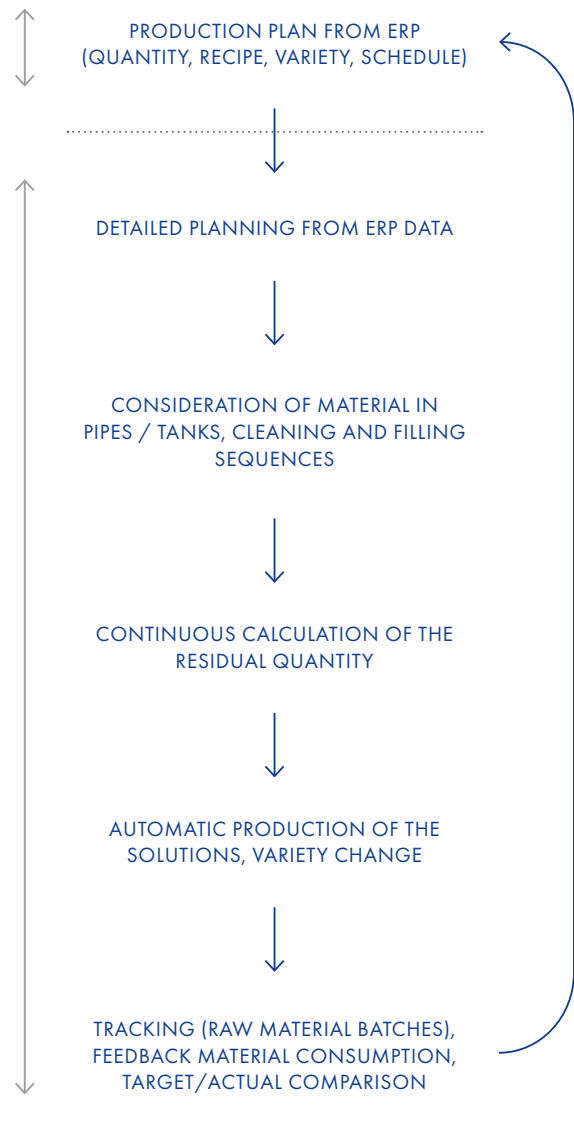
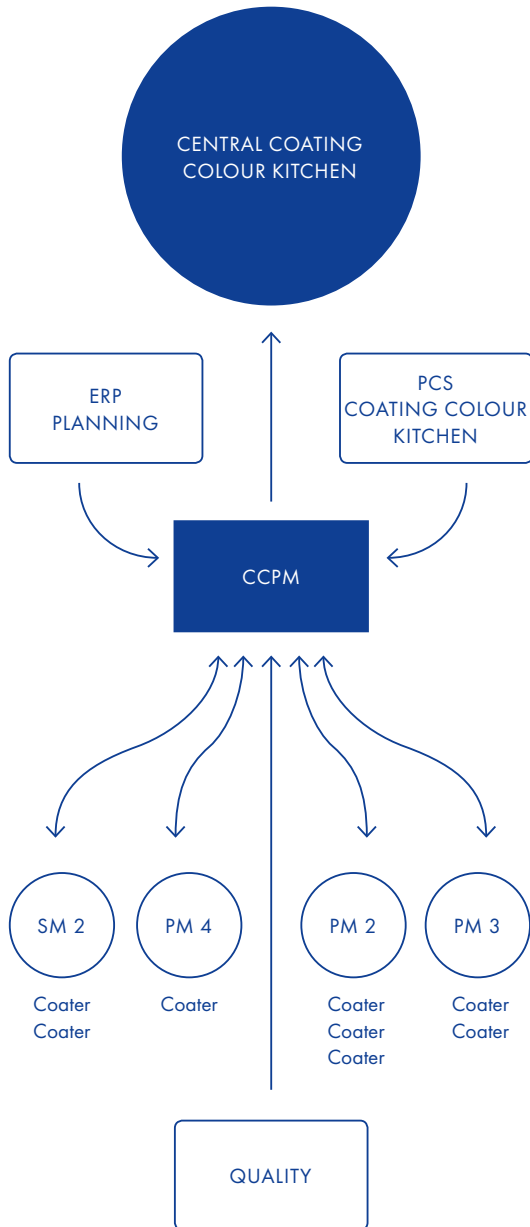

Mayr-Melnhof Karton, GAW technologies, AutomationX



“With **FOODBOARD™**, Mayr-Melnhof Karton has made a real breakthrough: an environmentally friendly paperboard with unique properties, enabling applications never before possible for paper-based packaging.”

Franz Rappold, Member of the Mayr-Melnhof Karton Management Board

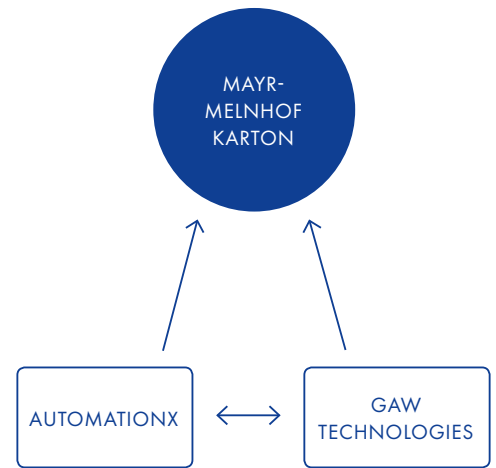

Quantum leap in cardboard production

Consumer safety is a top priority for the food packaging supply chain. **FOODBOARD™** by Mayr-Melnhof Karton represents a quantum leap in the protection of carton-packed food. An innovative, environmentally friendly and consumer-friendly barrier concept forms the core component. This perfectly protects the packaged food from unwanted substances in the packaging environment.

Over five years of research and development, thousands of migration analyses, and millions of pieces of produced safe folding box board made from **FOODBOARD™** have made this future technology ready for industrial production.

GAW technologies and AutomationX are grateful to have contributed to this quantum leap in paperboard production and to extend the decades-long partnership with this promising chapter, strengthening the technological

competitive position of Mayr-Melnhof Karton.

Automatic traceability – safety from delivery to the final product

As part of the milestone project, AutomationX implemented an MES solution for product traceability in coating colour preparation. Here it was a matter of mastering the challenge of fulfilling the legal requirements of the food sector and minimizing the cost of any enquiry calls.

Barrier coating – master test in future technology

The implementation of the trend-setting barrier coating concept of Mayr-Melnhof Karton in the field of cardboard production necessitated extensive rebuilding and expansion of the coating compound preparation systems.

The master test for such demanding barrier coatings is meeting the special

requirements of the coating material. GAW technologies developed deaerators for these applications which are specially tailored to the needs of the cardboard industry.

Owens Corning



Founded in 1948, Owens Corning has grown to become the world's largest producer of building materials, fibreglass reinforcements and thermal composite systems, with nearly 15,000 employees in twenty-seven countries on all five continents. GAW technologies congratulates Owens Corning for successfully commissioning the new system in Gastonia, NC, and is grateful and proud to have contributed to this milestone project.

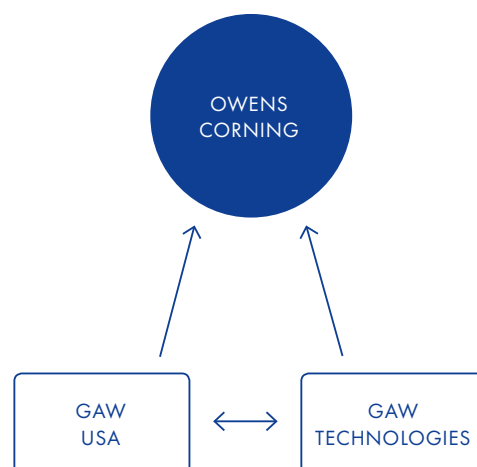

"Building a new system has been a great opportunity for us to implement the latest manufacturing processes," said Steven Vermeulen, Vice President and Managing Director, Engineered Solutions.

With the construction of the factory in Gastonia, North Carolina, Owens Corning has responded to the massive increase in demand for bio-based building materials. The Sustaina® glass veil manufactured in the flagship of the US group is made from a bio-based binder system with enormous resistance to breakage. It also contains no formaldehyde.

As part of the project, the bio-based binder system preparation process became the key to success, and GAW technologies was hired by Owens Corning to solve this problem for this milestone project.

In excellent cooperation with the GAW USA team under the leadership of Adam Glowacki, the challenge of delivering a key system to prepare a biobased binder system was mastered with flying colours.

"It was clear to us that the goal of maximum flexibility in the system can only be achieved with our Variable Shear Technology. The collaboration with Owens Corning and the great team from GAW technologies was excellent."

GAW supplied feed hoppers for powder processing, the tank farm and the key components for processing the bio-based binder system, in particular dispersing machines, agitators, pumps, screw conveyors, filter stations and instrumentation. Likewise, process and electrical engineering were taught by the GAW team.

"Thank you for your great performance in building our new flagship in Gastonia, NC. GAW's contribution to binder processing was sensational. That was the critical part of a challenging project for us, and you delivered!" Steve Nowak, Vice President, Global Sourcing.

Innovation and Development

Laboratory and technical centre



Innovation and development have always been a high priority at GAW technologies. Up to ten percent of the company's turnover is spent on innovation and development and on order-related development each year.

The driving force behind the global success of GAW technologies is innovation. Consistent investments in the I&D, with the claim to specialization in conjunction with technology and quality leadership, secure the future as an international company operating in extremely demanding business areas.

In doing so, GAW technologies relies on a synergetic network of know-how within the group of companies as well as on cooperation with national and international universities, colleges, research institutes and in particular on joint developments with their customers.

In these development partnerships with key customers, the result of long-term relationships and the resulting confidence, processes and key components are continually being improved and further developed in order to continuously expand the technology and quality leadership of GAW technologies.

The focus is always on the goal of increasing the productivity and energy efficiency of our customers plants, minimizing their operating costs and increasing environmental protection through the development of tailor-made customized technologies.

At the GAW technologies technical centre, experienced key innovators are dedicated to the continuous development and improvement of GAW key components.

The technical centre, equipped with GAW key components, pilot systems and extensive laboratory equipment, is available for development projects, pilot trials and test series from, for and with our customers.



The GAW Group

The GAW Group is a group of technology companies operating worldwide. The portfolio includes plant construction, products and industrial services, and serves five essential markets in almost every region of the world: paper, plastics, chemicals, environmental and automotive.

The operational business of the GAW Group is concentrated in the Paper & Pulp, Automotive, Chemical and Plastic Industries and Automation Divisions.

A substantial part of the worldwide production of coated paper and board is achieved using processing equipment from GAW. Global market leading automobile manufacturers rely on conveyor technology developed by GAW. Special machinery and recycling units from the GAW companies in the plastics division are successfully established throughout the world. automationX® solutions from our automation division have been steadily promoted in the areas of food, building material, process and infrastructure.

Founded in 1951, the GAW Group is today present in seventeen countries and has more than 500 employees. It achieves an annual turnover of EUR 102 million and maintains a widespread network of production facilities, service and sales offices on every continent in the world.

In 2017, the RAG-Stiftung Beteiligungsgesellschaft invested in the GAW Group as part of its long-term investment strategy and acquired a minority interest. The RAG Beteiligungsgesellschaft represents a trustworthy and reliable partner for the strategic corporate development of the GAW Group.





FACT SHEET

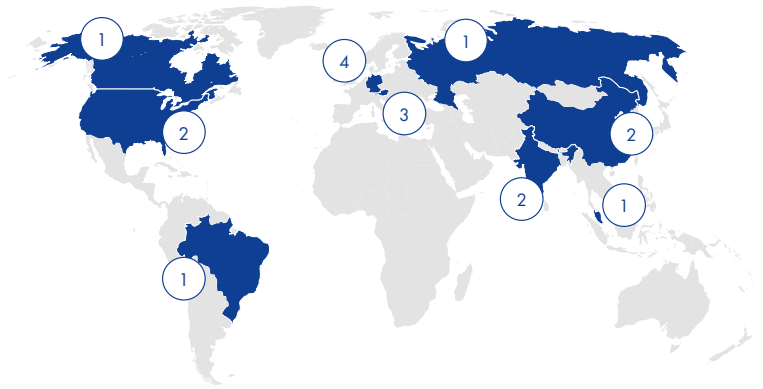

GAW Group

GAW Group Locations

17 —————> Locations

102 million —————> EUR turnover

8.4 % —————> I&E spending

95 % —————> Export quota

500 —————> Employees

Corporate structure of the GAW Group

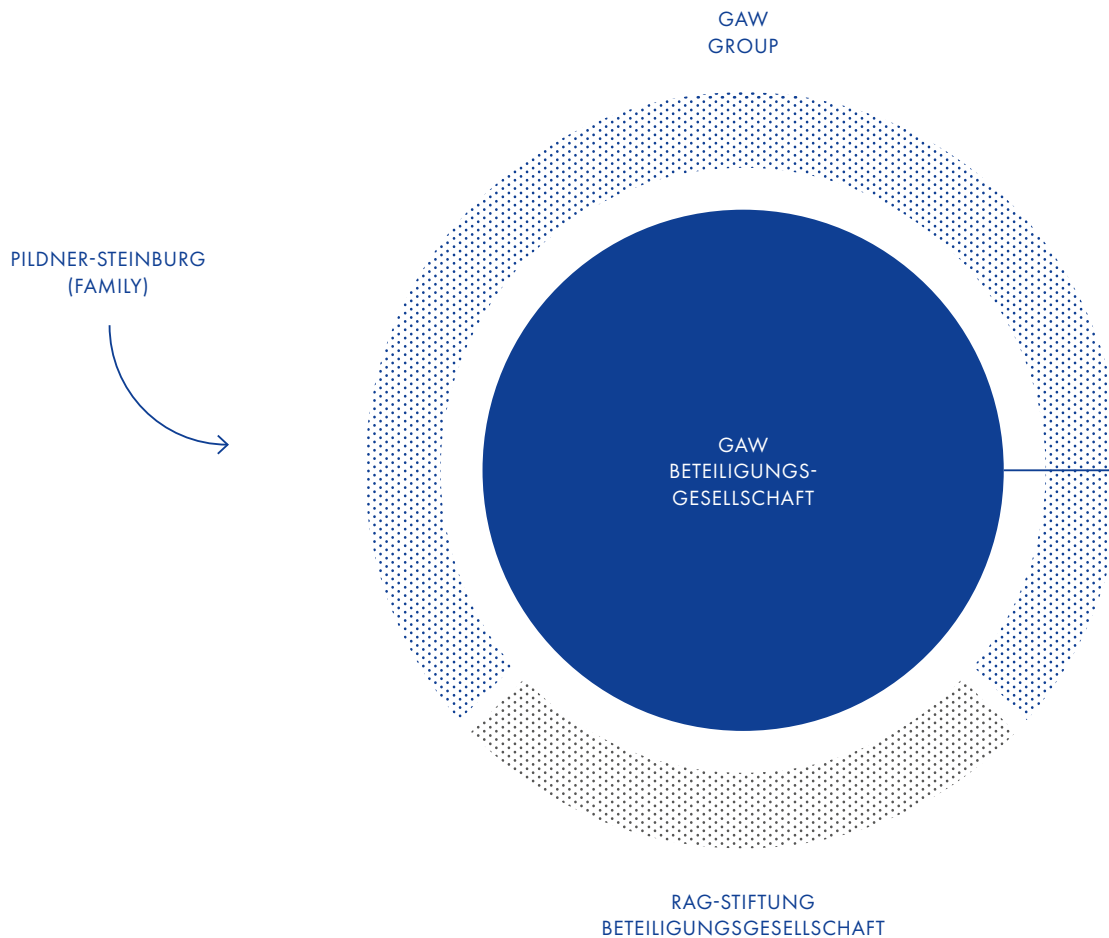

Pildner-Steinburg Family

The GAW Group, headquartered in Graz, Austria, is the management holding company of the group and is 100% owned by the Pildner-Steinburg family.

The GAW Group

The GAW Group is a global technology group with a portfolio of plant engineering, mechanical engineering and automation companies.

RAG-Stiftung Beteiligungs GmbH

Since 2017, the RAG-Stiftung Beteiligungs-gesellschaft has been a trusted and reliable partner in the strategic corporate expansion of the GAW Group.

GAW Beteiligungs GmbH

GAW Beteiligungs-gesellschaft manages the operating units of the technology group and is responsible for corporate development.

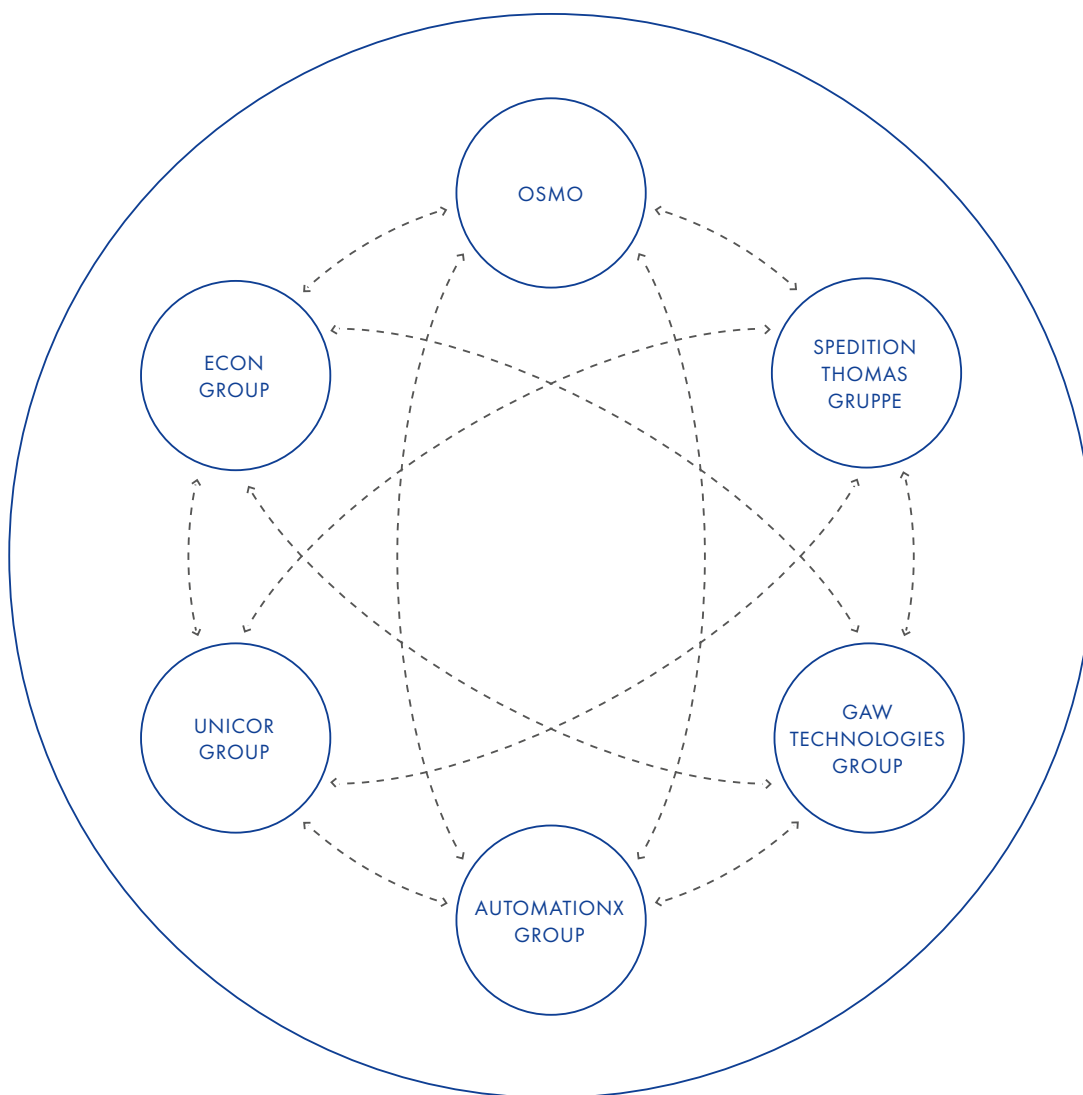

GAW technologies Group

World market leader in processing plants for the production and coating of paper and board, reliable partner for conveyor technology in the automotive industry. Enables efficient process solutions in the chemical industry and environmental technology.

AutomationX Group

Global technology company with a focus on integrated total solutions in the field of automation technology.

Unicorn Group

World market leader in the development and production of specific corrugators specially designed to meet the needs of corrugated pipe manufacturers.

Econ Group

Innovation leader in granulation systems. World-leading technology in machine manufacturing for the plastics production and processing industry. The specialist for under-water pelletising.

OSMO

Development and realization of high-end industrial membrane separation systems for a wide variety of process applications and water treatment. Special equipment for the chemical industry, high-pressure reverse osmosis systems, innovative water treatment.

Spedition Thomas Gruppe

Complete logistics provider with international partnerships. In addition to the pure transport business, offers comprehensive logistics services worldwide. Optimal solutions from a single source, tailored to the needs of customers.

Imprint

GAW technologies GmbH

Puchstrasse 76 / PF 64

8020 Graz, Austria

Tel.: +43 (0) 316 27 04-0

Fax: +43 (0) 316 27 32 66

office@gaw.at